

READY FOR  
WCDMA



## Vector Signal Generator R&S SMIQ

### Digital signals of your choice

- Frequency range 300 kHz to 2.2 GHz/3.3 GHz/4.4 GHz/6.4 GHz
- Analog and digital modulation
- Versatile and broadband generation of digitally modulated signals up to 18 Msymbol/s
- Generation of TDMA, CDMA, WCDMA and CDMA2000 standard signals to all main mobile radio standards
- Broadband I/Q modulator with outstanding vector accuracy
- Optional internal fading simulator to test specifications of mobile radio standards
- Optional internal noise generator and distortion simulator
- Optional BER measurement
- Optional arbitrary waveform generator
- Low ACP for IS-95 CDMA and WCDMA (option)
- Low cost of ownership due to three-year calibration intervals
- Future-oriented platform concept

The right option for every application

APPLICATION <sup>1)</sup>	R&S SM-B1	R&S SM-B5	R&S SMIQB11 <sup>2)</sup>	R&S SMIQB12	R&S SMIQB14	R&S SMIQB15	R&S SMIQB17	R&S SMIQB20	R&S SMIQB21 <sup>2)</sup>	R&S SMIQB42 <sup>3)</sup>	R&S SMIQB43 <sup>3)</sup>	R&S SMIQB45 <sup>3)</sup>	R&S SMIQB47	R&S SMIQB48	R&S SMIQB60	R&S SMIQB11	R&S SMIQB12
Reference Oscillator OCOXO																	
FM/φM Modulator																	
Data Generator (1.5 Mbit RAM)																	
Memory Extension, 32 Mbit																	
Fading Simulator (6 paths)																	
2nd Fading Simulator (6 paths)																	
Noise Generator and Distortion Simulator																	
Digital Modulation Coder																	
<sup>2)</sup> BER measurement																	
<sup>3)</sup> Digital Standard IS-95 CDMA																	
<sup>3)</sup> Digital Standard WCDMA (NTT DoCoMo 1.0, ARIB 0.0)																	
<sup>3)</sup> Digital Standard WCDMA according to 3GPP (FDD)																	
Low ACP for IS-95 CDMA and WCDMA																	
Extended Functions for WCDMA 3GPP																	
Arbitrary Waveform Generator																	
Digital Standard IS-95 CDMA (with ARB R&S SMIQB60)																	
Digital Standard CDMA-2000 (with ARB R&S SMIQB60)																	
<b>TDMA</b>																	
To standard	<input type="radio"/>	<input type="radio"/>	<input checked="" type="radio"/>	<input type="radio"/>	<input type="radio"/>	<input type="radio"/>	<input type="radio"/>	<input type="radio"/>	<input checked="" type="radio"/>	<input type="radio"/>	<input type="radio"/>	<input type="radio"/>	<input type="radio"/>	<input type="radio"/>	<input type="radio"/>	<input type="radio"/>	<input type="radio"/>
Non-standard	<input type="radio"/>	<input type="radio"/>	<input checked="" type="radio"/>	<input type="radio"/>	<input type="radio"/>	<input type="radio"/>	<input type="radio"/>	<input checked="" type="radio"/>	<input type="radio"/>	<input type="radio"/>	<input type="radio"/>	<input type="radio"/>	<input type="radio"/>	<input type="radio"/>	<input type="radio"/>	<input type="radio"/>	<input type="radio"/>
<b>CDMA IS-95</b>																	
To standard	<input type="radio"/>	<input type="radio"/>	<input checked="" type="radio"/>	<input type="radio"/>	<input type="radio"/>	<input type="radio"/>	<input type="radio"/>	<input checked="" type="radio"/>	<input type="radio"/>	<input checked="" type="radio"/>	<input type="radio"/>	<input type="radio"/>	<input type="radio"/>	<input type="radio"/>	<input type="radio"/>	<input type="radio"/>	<input type="radio"/>
<b>WCDMA</b>																	
To standard	<input type="radio"/>	<input type="radio"/>	<input checked="" type="radio"/>	<input type="radio"/>	<input type="radio"/>	<input type="radio"/>	<input type="radio"/>	<input checked="" type="radio"/>	<input type="radio"/>	<input type="radio"/>	<input checked="" type="radio"/>	<input checked="" type="radio"/>	<input checked="" type="radio"/>	<input type="radio"/>	<input type="radio"/>	<input type="radio"/>	<input type="radio"/>
<b>CDMA 2000</b>																	
To standard	<input type="radio"/>	<input type="radio"/>	<input checked="" type="radio"/>	<input type="radio"/>	<input type="radio"/>	<input type="radio"/>	<input type="radio"/>	<input checked="" type="radio"/>	<input type="radio"/>	<input type="radio"/>	<input type="radio"/>	<input type="radio"/>	<input type="radio"/>	<input type="radio"/>	<input type="radio"/>	<input checked="" type="radio"/>	<input checked="" type="radio"/>
<b>Fading</b>																	
	<input type="radio"/>	<input type="radio"/>	<input type="radio"/>	<input type="radio"/>	<input checked="" type="radio"/>	<input type="radio"/>	<input type="radio"/>	<input type="radio"/>	<input type="radio"/>	<input type="radio"/>	<input type="radio"/>	<input type="radio"/>	<input type="radio"/>	<input type="radio"/>	<input type="radio"/>	<input type="radio"/>	<input type="radio"/>
<b>Vector modulation</b>																	
	<input type="radio"/>	<input type="radio"/>	<input type="radio"/>	<input type="radio"/>	<input type="radio"/>	<input type="radio"/>	<input type="radio"/>	<input type="radio"/>	<input type="radio"/>	<input type="radio"/>	<input type="radio"/>	<input type="radio"/>	<input type="radio"/>	<input type="radio"/>	<input type="radio"/>	<input type="radio"/>	<input type="radio"/>
<b>Analog modulation (AM, FM, φM)</b>																	
	<input type="radio"/>	<input checked="" type="radio"/>	<input type="radio"/>	<input type="radio"/>	<input type="radio"/>	<input type="radio"/>	<input type="radio"/>	<input type="radio"/>	<input type="radio"/>	<input type="radio"/>	<input type="radio"/>	<input type="radio"/>	<input type="radio"/>	<input type="radio"/>	<input type="radio"/>	<input type="radio"/>	<input type="radio"/>
<b>Fast setting time</b>																	
	<input type="radio"/>	<input type="radio"/>	<input type="radio"/>	<input type="radio"/>	<input type="radio"/>	<input type="radio"/>	<input type="radio"/>	<input type="radio"/>	<input type="radio"/>	<input type="radio"/>	<input type="radio"/>	<input type="radio"/>	<input type="radio"/>	<input type="radio"/>	<input type="radio"/>	<input type="radio"/>	<input type="radio"/>

1) R&S SMIQ02B/03B (R&S SMIQ04B/06B) can be equipped with up to three (two) of the following options: R&S SM-B5, R&S SMIQB14, R&S SMIQB15 or R&S SMIQB17  
 2) Option R&S SMIQB20 required  
 3) Options R&S SMIQB20 and R&S SMIQB11 required  
 ● = required      ○ = optional

R&S SMIQ rear panel



## A safe investment for the future ...

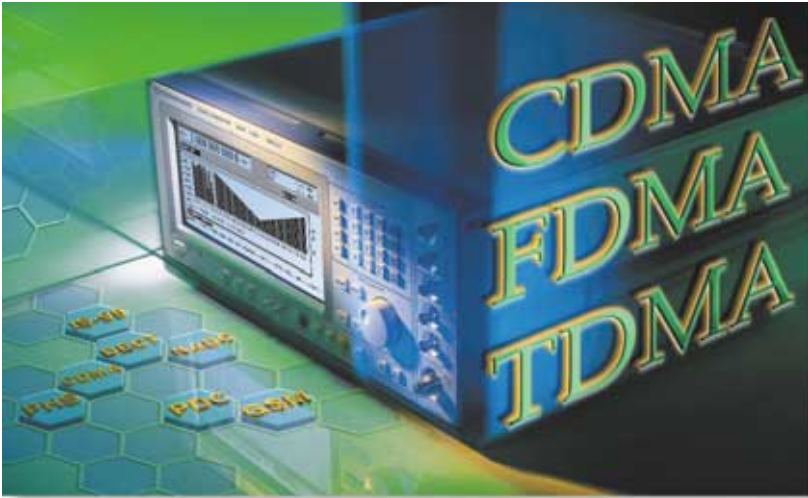

The B series of Signal Generator Family R&S SMIQ for analog and digital modulation from Rohde&Schwarz is offering solutions for today and tomorrow. This series particularly takes into account future developments in the field of 3rd-generation digital mobile radio.

The R&S SMIQ family comprises four models which differ in their upper frequency limits. These feature a hitherto unrivalled versatility regarding signal

The wide frequency range from 300 kHz to 6.4 GHz covers all main radio bands including their IF ranges.

The high-grade I/Q modulator fitted as standard ensures minimum error vector magnitude and high intermodulation suppression.

Using modern digital signal processor (DSP) technology, the versatile concept allows the generation of high-precision digital modulation signals with high bit rates without any limitations on modulation modes or standards.

SMIQ02B*)	300 kHz to 2.2 GHz
SMIQ03B*)	300 kHz to 3.3 GHz
SMIQ04B*)	300 kHz to 4.4 GHz
SMIQ06B	300 kHz to 6.4 GHz

generation and signal quality and are therefore ideal for use in development and type-approval testing.

With their outstanding price/performance ratio, these signal generators are also economically attractive for applications in production.

In addition to digital modulation, the signal generators provide the full range of analog modulation modes as well as simultaneous modulation capability.

\*) Every model upgradable up to 6.4 GHz

# R&S SMIQ – a signal generator family ...

## Digital modulation

### Any digital modulation modes (with option R&S SMIQB20)

- Free choice of modulation mode from ASK through to 256QAM
- Any kind of baseband filtering with variable filter parameters
- Symbol rate adjustable up to 18 Msymbol/s
- Realtime coding of internal and external data
- Internal PRBS generators

### Convenient burst generation for TDMA standards (with option R&S SMIQB20/ R&S SMIQB11)

- TDMA mobile radio standards provided as standard GSM, GSM-EDGE, DECT, NADC (IS-54C/IS-136), PDC, PHS
- Versatile external synchronization capabilities
- Realtime processing of external and internal data

- Generation of TDMA frames with versatile timeslot configuration
- Continuous PRBS sequences
- Optimization of burst shaping to reduce spectra due to switching
- Realtime processing with external data for BER tests
- Slot-by-slot modulation change for TDMA
- Signals with preprogrammed frame structure

### Up to 79 Mbit internal data memory (with 2 x option R&S SMIQB12)

### Optional multichannel WCDMA signals for 3GPP (FDD) systems (R&S SMIQB45)

### Optional cdma2000 standard (R&S SMIQB60 + R&S SMIQK12)

### Optional WCDMA standard to ARIB0.0 standard and NTT DoCoMo 1.0 (R&S SMIQB43)

### Optional CDMA standard to IS-95 (R&S SMIQB42 or R&S SMIQB60 + R&S SMIQK11)

## Special options

### Fading simulation (options R&S SMIQB14 and R&S SMIQB15)

- Fading of internal or external I/Q signals conforming to mobile radio standards
- 6-path simulation can be enhanced to 12-path simulation (2-channel fading also possible with second vector signal generator)
- Selectable path attenuation and delay
- Simulation of high speeds
- Preprogrammed fading profiles for mobile radio standards GSM, NADC, IS-95 CDMA and TETRA

## Analog modulation

- Broadband AM with up to 30 MHz modulation frequency
- I/Q modulation with 30 MHz modulation bandwidth (3 dB), 60 MHz RF bandwidth
- Unprecedented vector accuracy and high intermodulation suppression
- Amplitude modulation
- Pulse modulation
- Optional frequency and phase modulation (R&S SM-B5)

## RF characteristics

- Wide output frequency range from 300 kHz to 6.4 GHz
- High (up to 16 dBm) and precise output level (<0.5 dB)
- Fast setting time for frequency (<3 ms) and level (<2.5 ms) \*)
- Frequency hopping (500  $\mu$ s)
- High spectral purity (typ. -130 dBc (1 Hz) at 1 GHz and 20 kHz carrier offset)
- RF, AF and level sweep (user-programmable)

\*) Without switching the mechanical attenuators

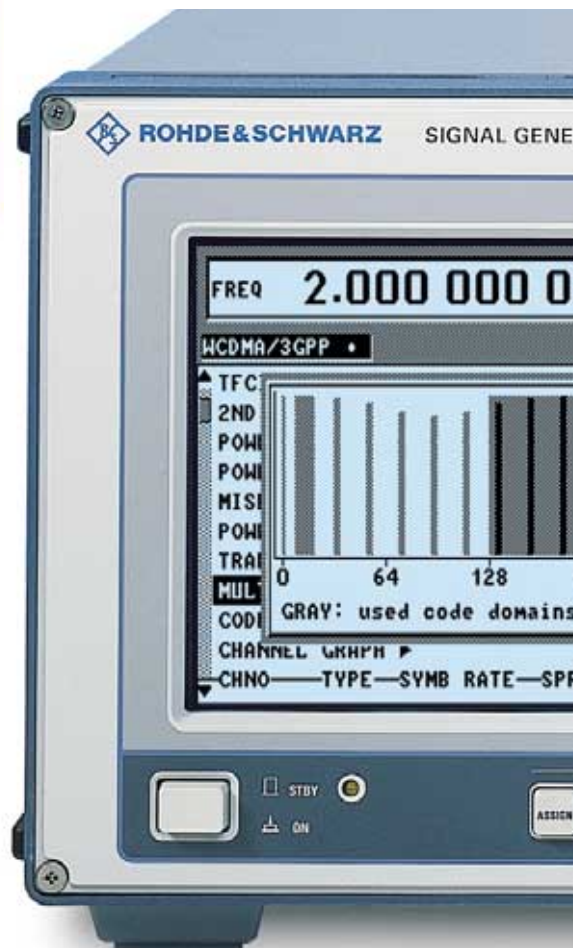

# ... for all requirements

- Frequency range of basic unit can be fully utilized
- Calibrated RF level in range from -140 dBm to -5 dBm
- Unrivalled price/performance ratio

### Noise generator and distortion simulator (option R&S SMIQB17)

- Simulation of amplitude and phase distortion (AM/AM and AM/φM characteristics)
- Distortion characteristics programmable from up to 30 input values

- Superimposed noise signals (AWGN)
- C/N ratio variable with high resolution over a wide range
- Broad noise bandwidth (10 kHz to 10 MHz)

### Bit error rate measurements (option R&S SMIQB21)

- Up to 30 MHz clock rate

### Low ACP for IS-95 CDMA and WCDMA (option R&S SMIQB47)

- Specially designed for 1.2288 Mcps

- (cdmaOne/cdma2000), 3.84 Mcps and 2 channels
- 3.84 Mcps/5 MHz offset (3GPP)
- Can be used with internal (option R&S SMIQB42/43/45) or external CDMA/WCDMA signals
- Typical WCDMA adjacent-channel power ratio (5 MHz offset, 3.84 Mcps): -67 dBc (1 DPCH)
- Typical IS-95 CDMA adjacent-channel power ratio (885 kHz offset): -78 dBc (9 code channels)

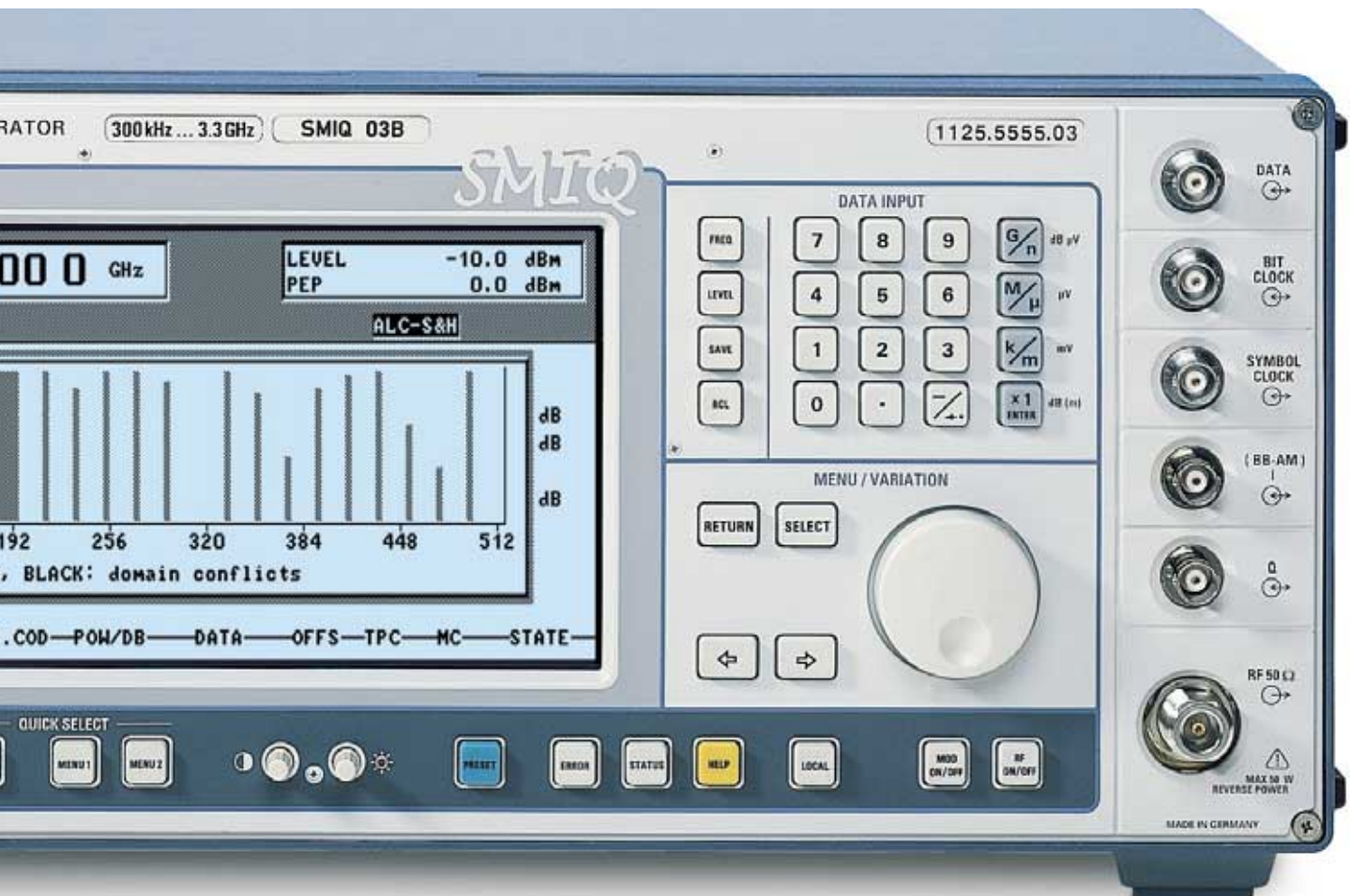

# Outstanding RF characteristics

## From 300 kHz to 6.4 GHz

With its wide frequency range, the R&S SMIQ family has the right model for every application. The uppermost frequency limit of 6.4 GHz leaves sufficient margin even for WLL (wireless local loop) systems. Frequency extension options allow upgrading to higher frequency limits.

## Level – high and precise

With a maximum output level of +13 dBm (+16 dBm in overrange) insertion losses caused by cables or switching matrixes can easily be compensated. For driving components with high input level the use of an external amplifier is not necessary.

A level accuracy of <0.5 dB allows high-precision measurements even on highly sensitive analog and digital receivers.

## Excellent spectral purity

R&S SMIQ provides output signals of excellent spectral purity. Low-noise frequency synthesis ensures modulation of highest quality for reliable test signals.

## Fast setting times

Fast setting times are among the most important criteria when it comes to choosing the right signal generator, especially in production.

The synthesizers of the R&S SMIQ family excel in this respect: with a frequency setting time of less than 3 ms they allow extremely fast measurements.

Besides standard sweep functions for RF, AF and level, R&S SMIQ features an extremely versatile and fast sweep mode for frequency and level settings to be carried out with the aid of stored lists. This mode with a setting time of less than 500  $\mu$ s is ideal for frequency hopping applications.

## Low cost of ownership

The use of high-precision reference elements with long-term stability ensures reliable operation over a long period of time. The three-year calibration intervals cut costs and increase availability.

## Designed for the future

The open concept of R&S SMIQ allows the functionality of the signal generator to be adapted to future requirements in a simple and cost-effective way.

Since R&S SMIQ uses programmable digital signal processing chips throughout, its capabilities are not limited by the hardware used.

New functions can be downloaded very simply via the serial interface of the generators.

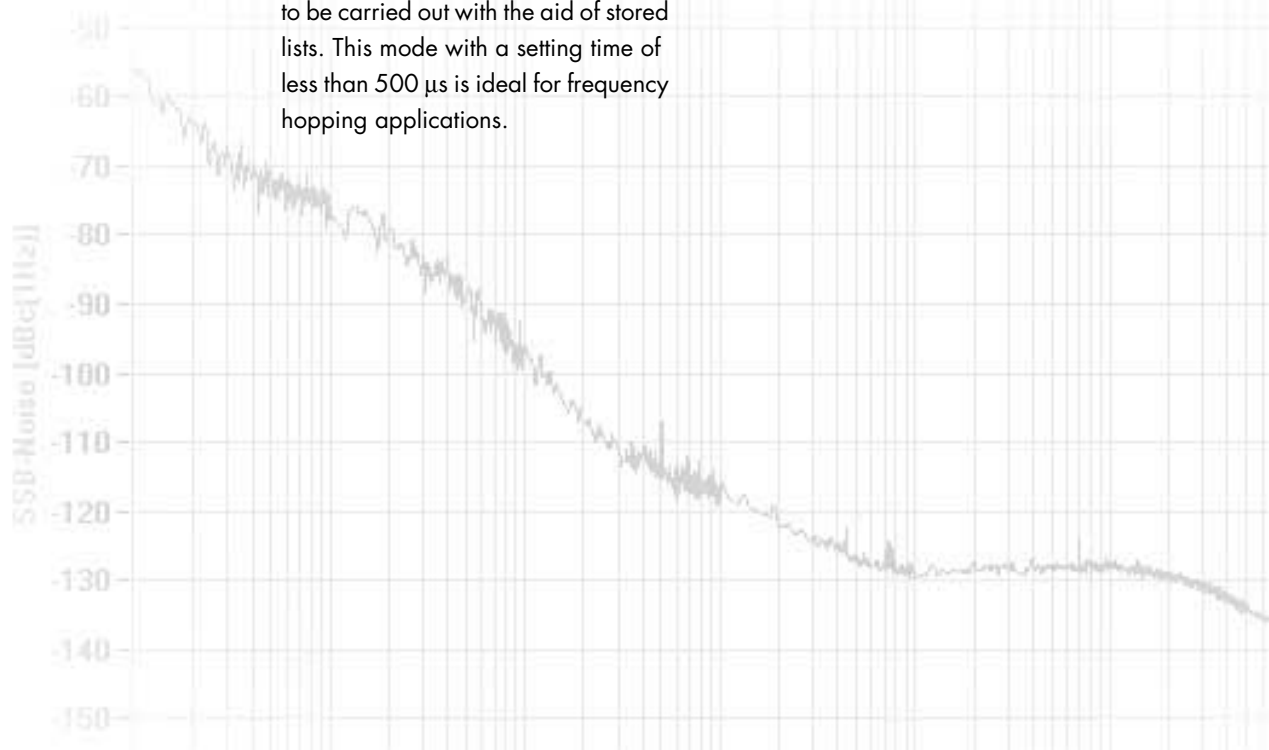

Typical level accuracy at 0 dBm

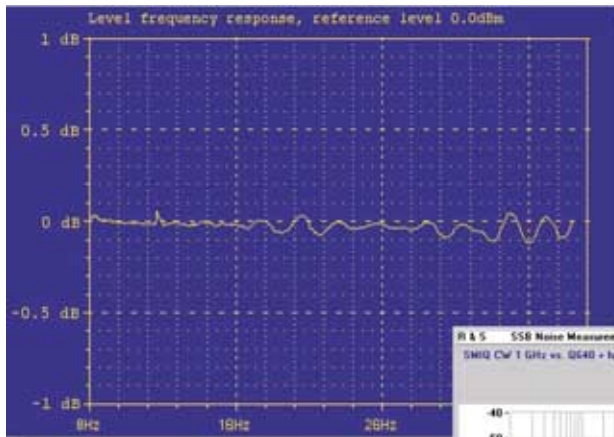

Typical I/Q frequency response

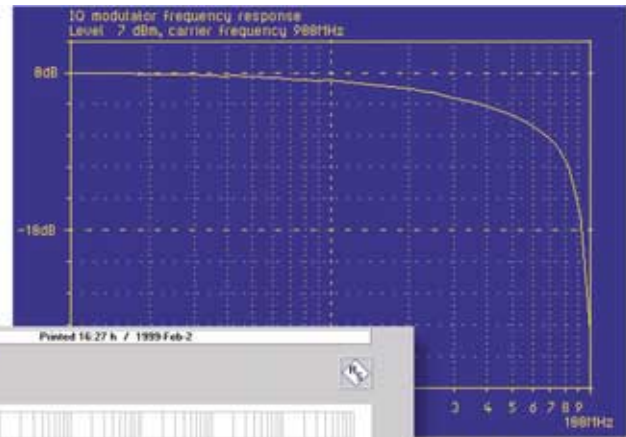
Typical SSB phase noise at  $f_c=1$  GHz

## Analog modulation

### Excellent analog characteristics

R&S SMIQ sets standards in the field of digital modulation – without any restrictions on the analog side.

#### Amplitude modulation

The modulation frequency range is DC to 50 kHz. Particularly noteworthy is the extremely low incidental phase modulation with AM, which plays an important role in AM sensitivity tests on FM receivers.

#### Frequency modulation (option R&S SM-B5)

The modulation frequency range is DC to 2 MHz. In the FM DC mode, extremely high carrier frequency accuracy is ensured through the use of a nov-

el control circuit. There is virtually no drift. This characteristic allows the digital signalling of receivers also by means of analog frequency modulation.

#### Phase modulation

Phase modulation ranges from DC to 100 kHz. This wide span opens up fields of application for which most signal generators do not qualify, for instance tests on phase-sensitive circuits or the generation of PSK modulation with freely selectable phase deviation.

#### IQ modulation at the highest level

The precision I/Q modulator of R&S SMIQ is the basis for the excellent modulation characteristics with spurious suppression of more than 70 dB.

In addition to a bandwidth that is designed for the needs of future broadband systems, the modulator features high intermodulation suppression which with digital modulation yields excellent characteristics regarding adjacent-channel power.

#### Broadband amplitude modulation

Broadband amplitude modulation (BB-AM) is provided as standard and allows accurate envelope control (eg for pulse shaping) or generation of analog video signals. It features high modulation quality and low incidental FM at modulation frequencies of up to 30 MHz (3 dB) and is generated via the I input of the I/Q modulator.

# Digital modulation

## Fit for every requirement

The rapidly changing digital communications market makes great demands on measurement technology: for one thing measurements need to be done fast in an uncomplicated way, for another investments made today should cover the requirements of tomorrow. R&S SMIQ is setting standards. It provides convenient generation of high-precision signals in line with today's digital standards and in addition allows free variation of all digital modulation parameters.

## TDMA, CDMA or WCDMA?

R&S SMIQ is at home in all access methods. It is just as good in generating versatile frame structures of all main TDMA systems as it is in CDMA and WCDMA applications.

## Universal modulation coder

The universal modulation coder (option R&S SMIQB20) is the core of complex digital modulation generation. From the digital input signals it derives the analog signals for the I/Q modulator of R&S SMIQ in realtime. The internal or external digital input signals are made up of serial or parallel data bit streams, clock signals, signals for burst control and triggering. A PRBS generator of different sequence lengths is contained in the modulation coder as an internal signal source.

The modulation coder allows free selection of the format, baseband filtering and symbol rate of digital modulation. The selected parameters can be varied within a wide range.

## Four ways of generating digital signals

Vector Signal Generators R&S SMIQ can generate digitally modulated signals in four different ways.

### 1. Vector modulation

In this mode, externally generated I/Q signals are applied to the I/Q modulator of R&S SMIQ. I/Q Modulation Generator R&S AMIQ together with Simulation Software R&S WinIQSIM™ are perfect tools for the generation of external I/Q signals.

### 2. Digital modulation

The universal modulation coder (R&S SMIQB20) and data generator (R&S SMIQB11) options provide a platform for generating digitally modulated signals that are variable in a wide range. Modulation mode, filtering, data source and symbol rate can be selected by the user.

### 3. Digital standards

The digital standards provide at a keystroke base-station and mobile-station signals to telecommunication standards – based on the capabilities of the optional digital modulation coder (R&S SMIQB20). The TDMA (time division multiple access) standards GSM, GSM-EDGE, DECT, NADC (IS-54C, IS-136), PDC and PHS come with the optional data generator (R&S SMIQB11). The CDMA standard IS-95 (R&S SMIQB42) or WCDMA according to NTT DoCoMo systems (R&S SMIQB43) as well as WCDMA according to 3GPP/FDD (R&S SMIQB45) are also available as an option. The number of future digital standards that can be simultaneously accommodated in R&S SMIQ is unlimited.

### 4. Arbitrary waveform generator

The arbitrary waveform generator (option R&S SMIQB60) is an integrated I/Q modulation source adding extra functionality to R&S SMIQ. It allows the generation of **arbitrary** modulation signals such as COFDM, multicarrier, or noise. The most convenient way of generating a wide variety of signals is by computing them with the supplied R&S WinIQSIM™ PC software and loading them into the unit (see data sheet PD 0757.3970). Signals computed with the aid of commercial mathematical programs can be transferred, too, using free-of-charge auxiliary software (R&S IQWizard).



## Comprehensive synchronization capabilities

The optional Data Generator R&S SMIQB11 with a memory of 15 Mbit, which can be extended up to 79 Mbit, is the internal data source for the modulation coder. These data are also available at the outputs, eg as reference for BER (bit error rate) measurements.

Up to six different control signals can be generated synchronously with the data bits to provide symbol-accurate trigger signals, control frequency hopping and mark level bursts. With the aid of these control signals external measurements can be synchronized.

The internally generated data streams of the data generator can conveniently be synchronized to external trigger events. A comprehensive range of functions such as trigger delay is available for this purpose. The switching threshold of the trigger input can be adjusted to the level of external signals.

## Convenient burst signal generation

Symbol-synchronous amplitude control of the RF signal is required especially for generating test signals for mobile radio systems using a TDMA method.

In addition to ensuring a large dynamic range, the switching of timeslots should be such that the spectrum due to switching is suppressed to a very high degree.

R&S SMIQ is ideal to meet these requirements. Convenient menus allow timeslots to be defined independently of one another, reduced in level or completely switched off. Moreover, the slew rate and the shape of the switching signal edge can be varied.



... fit already today for tomorrow's communication

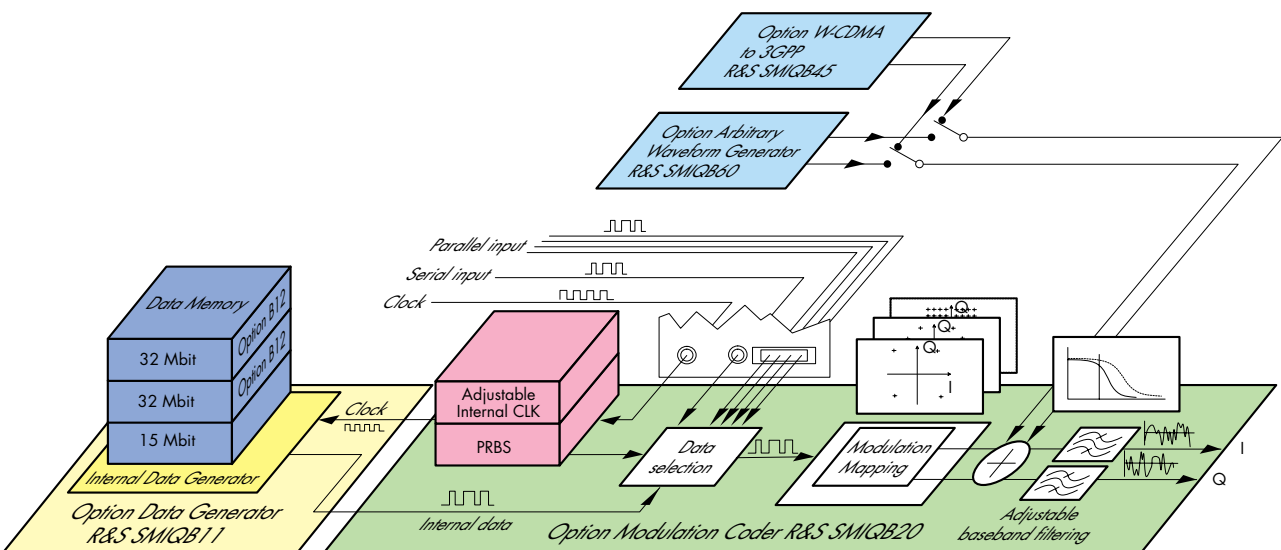

Principle of digital modulation signal generation

# Digital modulation

## Standards

R&S SMIQ fitted with the two options modulation coder (R&S SMIQB20) and data generator (R&S SMIQB11) provides standard-conformal signals for testing mobile and base stations of the main mobile radio networks. These test signals contain the necessary protocol information and frame structures for testing receivers.

The timeslots (bursts) and their data contents can be specified for the TDMA standards GSM, GSM-EDGE, DECT, NADC, PDC and PHS via user-friendly menus. The main burst types are predefined and available at a key-stroke. They can easily be modified, stored and reused for tests.

Continuous PRBS data streams and internally generated data lists as well as externally provided serial data streams can be inserted in realtime into the data fields of the frame structures.

### GSM Global System for Mobile Communication

Frames and timeslot configuration conform to the GSM standard. Each timeslot (burst) has a certain data structure depending on its use, eg as traffic channel or channel for frequency synchronization.

### GSM-EDGE System for Mobile Communication

In comparison with GSM and GMSK modulation GSM-EDGE is based on 8PSK with  $3\pi/8$  rotated modulation. Modulation change between GMSK and 8PSK is possible slot by slot.

GSM spectrum

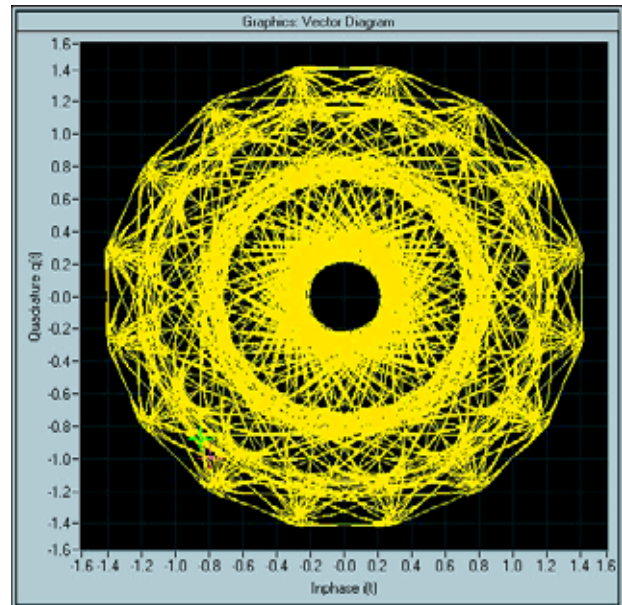
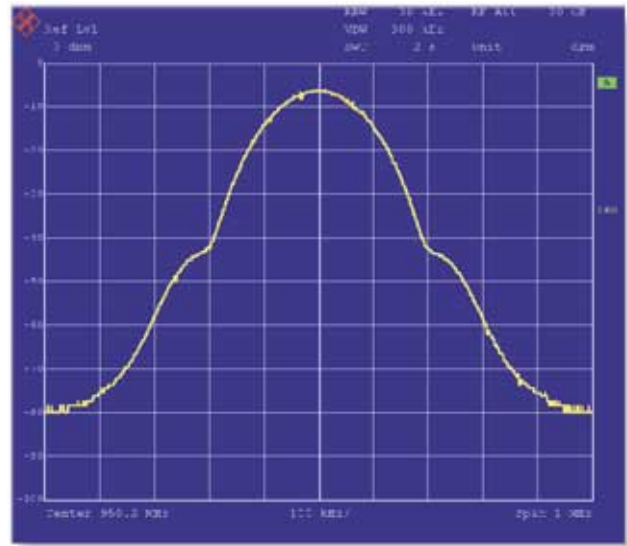

EDGE vector diagram

### DECT Digital Enhanced Cordless Telecommunication Standard

This operating mode allows signals to be generated to ETSI DECT standard.

### NADC North American Digital Cellular (IS-54C, IS-136)

The data protocol structure conforms to NADC specifications IS-54C and IS-136. The following predefined burst types are available: uplink burst, downlink burst, all data.

## PDC Personal Digital Cellular (RCR STD-27C)

The data protocol structure conforms to PDC specification RCR-27C. This standard is largely identical with the NADC standard.

## PHS Personal Handy Phone System (RCR STD-28)

The data protocol structure conforms to PHS specification RCR-28. The following predefined burst types are provided: control physical slot, communication physical slot, sync, TCH, VOX, all data.

## CDMA IS-95 Code Division Multiple Access (with option R&S SMIQB42)

For the CDMA base-station signal (forward link) up to 64 code channels can be generated with user-selected Walsh codes. The power of the code channels can be selected independently for up to four channels. The channel data consist of various internal PRBS or fixed data patterns.

The mobile-station signal (reverse link) can be configured for full-rate as well as for half-rate operation. Moreover it is possible to generate a channel-coded reverse-link signal.

## WCDMA to NTT DoCoMo and ARIB (with option R&S SMIQB43)

WCDMA is one of the favoured technologies for 3rd generation mobile radio.

Fitted with option WCDMA (R&S SMIQB43), R&S SMIQ is able to generate WCDMA signals to the Japanese specifications of NTT DoCoMo and ARIB<sup>1)</sup>.

<sup>1)</sup> Association of Radio Industries and Businesses (ARIB), Specifications of Air Interface for a 3 G Mobile System

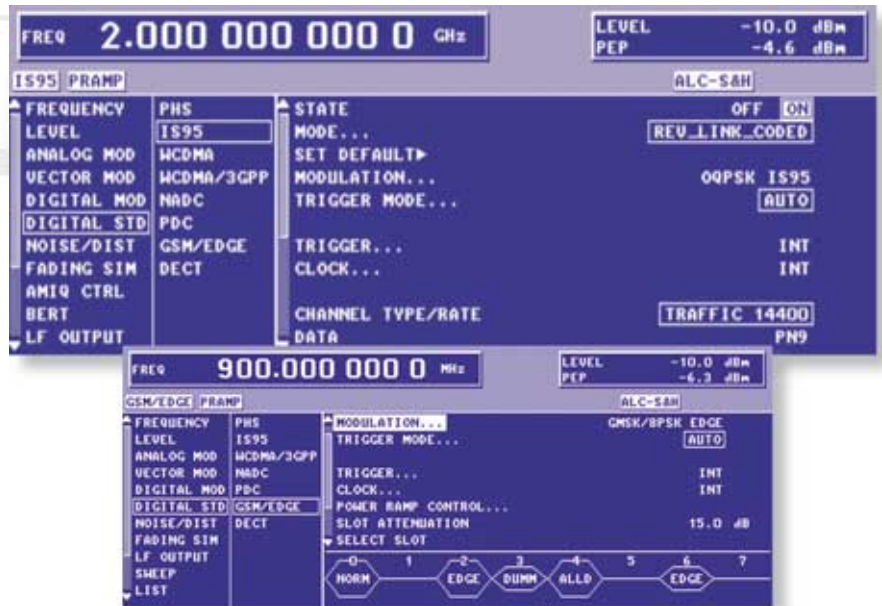

Like with IS-95 CDMA, uplink (mobile station to base station) and downlink (base station to mobile station) can be simulated with up to 15 code channels. A chip rate of 4.096 Mcps is preset, but can be varied any time.

There is a choice of different types of physical channels, such as perch, common control or dedicated physical channels. The frame structure consisting of various data fields (traffic power control or long code mask symbol) is automatically generated for each type of channel.

## WCDMA to 3GPP/FDD (with option R&S SMIQB45)

Software option R&S SMIQB45 supports the generation of downlink and uplink signals in line with the 3GPP standard (FDD mode). As the standardization process is not yet completed, the functionality of this option will continuously be adapted to the relevant standard modifications and expansions (for functionality see specifications).

The physical channels including their slot structure are simulated as a whole. Therefore the signals exactly conform to the 3GPP standard regarding timing, spectral distribution and amplitude probability distribution and thus allow correct measurements on the components to be tested.

# Digital modulation

Signals can be configured in many different ways:

- The current 3GPP standard is supported, stipulating a chip rate of 3.84 Mcps and 15 slots/frame.
- Up to four base or mobile stations with separately selected scrambling code can be simulated. One BS may have up to 128 data channels in addition to special channels. An MS can be operated in the three modes PRACH only, PCPCH only and DPCCH + DPDCH (max. 6 DPDCHs).
- Symbol rate, channelization code, power (can even be varied in time) as well as data contents and timing offset can be selected for each code channel (timing offset can be used to influence signal statistics and thus crest factor).
- P-/S-CPICH, P-/S-SCH, P-/S-CCPCH, AP-/CD-AICH, PDSCH, DL-DPCCH and DPCHs with their corresponding slot structure can be generated in the downlink.
- Transmit diversity is also already supported.
- The clipping function allows simple simulation of the clipping measures implemented in every base station.
- With the R&S SMIQ firmware version 5.70 or higher, WCDMA 3GPP (FDD) signals are generated to 3GPP version 4.1.0. For the downlink, test models 1 (with 16/32/64 channels), 2, 3 (16/32 channels) and 4 have been implemented (to TS25.141). This enables the user to activate downlink test signals to 3GPP specification with a keystroke. There are two non-standardized test scenarios available for the uplink (DPCCH + 1 DPDCH at 60 ksps and DPCCH + 1 DPDCH at 960 ksps).

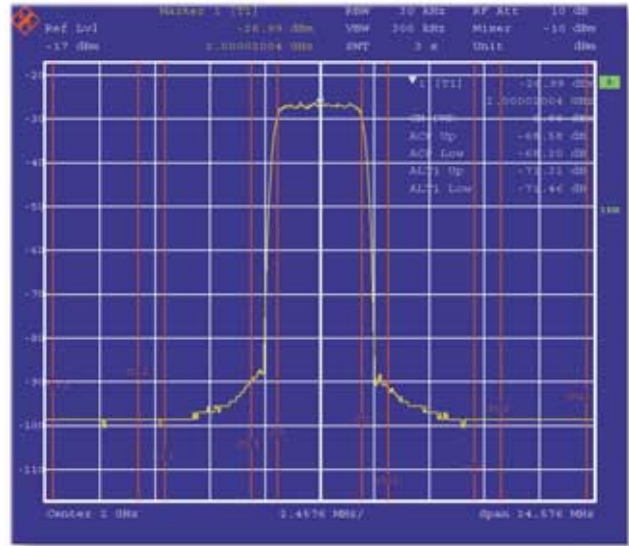

WCDMA spectrum

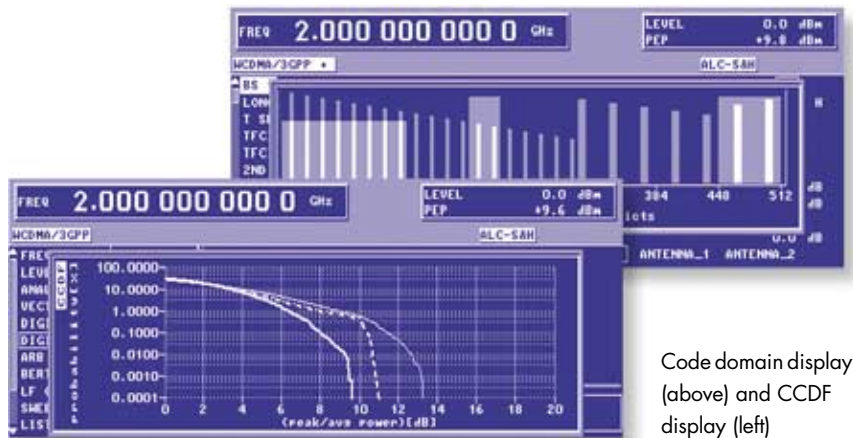

Code domain display (above) and CCDF display (left)

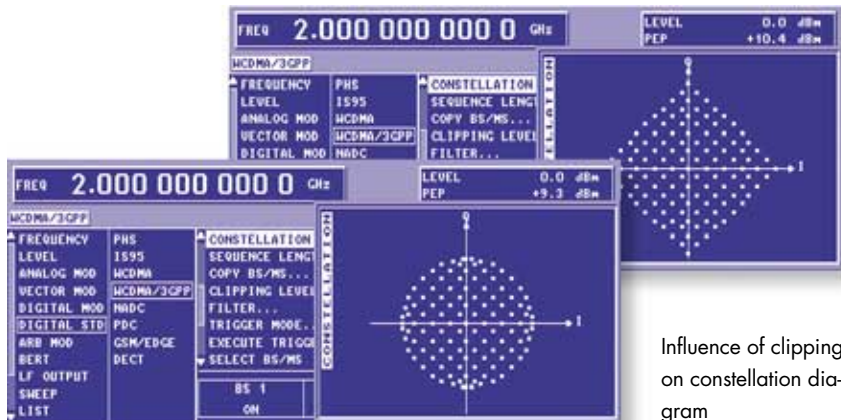

Influence of clipping on constellation diagram

- The long signal length of up to 13 frames (with 3.84 Mcps) allows realistic signals to be generated.

Despite the large variety of functions provided by this option, WCDMA signals can quickly be generated with the aid of assistant functions. With the aid of predefined settings which may additionally be varied through the selection of the crest factor and the number of data channels a WCDMA signal can be generated with a few keystrokes. Further editing tools allow simultaneous configuration of numerous data channels and copying of a complete BS or MS configuration.

But there is much more. R&S SMIQ also provides numerous tools for checking the selected settings: overlapping of individual code channels in the code domain (domain conflicts) is displayed and can automatically be resolved by a key-stroke. The graphic display of constellation diagram, CCDF, occupied code domain and active channels allows the generated signals to be checked for conformance to expectations even without the use of an analyzer.

### Enhanced functions for WCDMA 3GPP (FDD) digital standard with option R&S SMIQB48

This option expands the functionality of option R&S SMIQB45 WCDMA

Display of power control graph with external power control



3GPP. It allows the generation of up to four enhanced channels that can be combined with the standard channels.

This opens up a variety of other applications:

- The maximum sequence length of four enhanced channels is 256 frames. If only one channel is required, the maximum is 1022 frames (compare sequence length with R&S SMIQB45: 13 frames). Very long signal sequences and continuous PRBS sequences (eg PN9) like those often required for BER measurements can thus be implemented for the channel under test.
- For the enhanced channels, data fields and the transmit power control (TPC) field of the slots can be filled from data lists. This allows the use of externally precoded data or the generation of long power control profiles for the DUT.

- The code channel power of enhanced channels can be varied **in real-time** by an external control signal. This enables testing the closed-loop power control function of a mobile station for example.
- From R&S SMIQ firmware version 5.40, the four enhanced channels feature channel coding both in uplink and downlink in accordance with the reference measurement channels definition. This enables receiver and performance tests to TS 25.101, TS 25.104 and TS25.14. In addition, 12.2 kbps AMR speech to TS 25.944 is supported. From R&S SMIQ firmware 5.85 also the channel coded RACH and CPCH to TS 25.141 are supported.

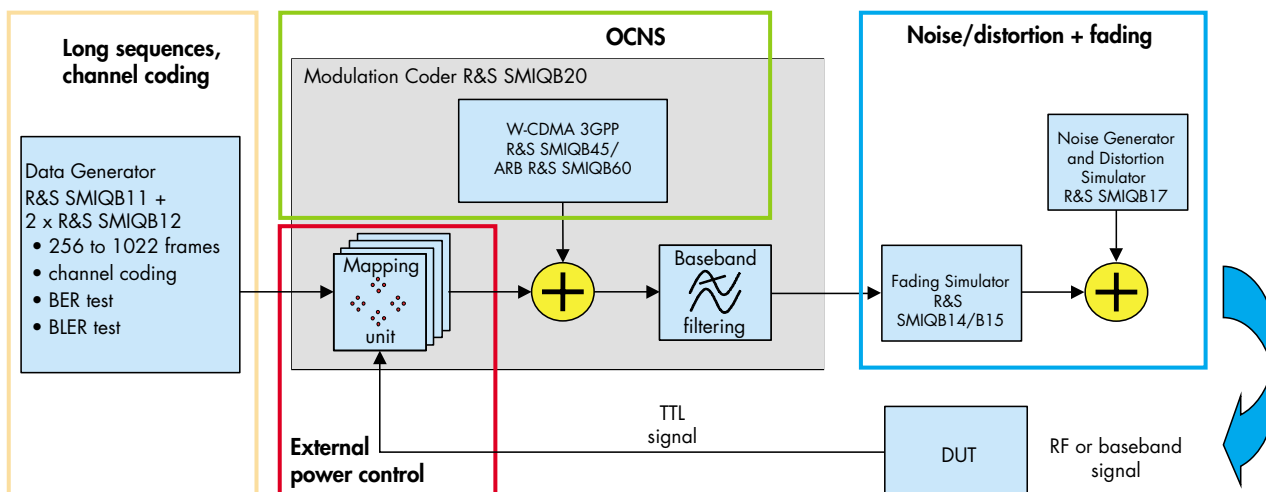

Option R&S SMIQB60: Complete test scenario with enhanced functions to digital standard WCDMA 3GPP (FDD)

# Digital modulation

- With the R&S SMIQ firmware version 5.65 or higher, the option R&S SMIQB48 makes it also possible to generate a realtime downlink broadcast channel (BCH) with an incrementing system frame number (SFN; 0 to 4094). The BCH can be combined with all reference measurement channels (RMC 12.2 kbps, 64 kbps, 144 kbps, 384 kbps) or an AMR (12.2 kbps). The sequence length of these channels (RMC and AMR) can be up to 2044 frames.

## Application examples:

- Receiver and performance tests to TS25.101
- Test of synchronization of mobile to a base-station signal combined with continuous measurement of DTCH and DCCH bit error rate and block error rate using a PN9 data sequence.
- For a realistic simulation of WCDMA scenarios, up to 64 background mobile stations can be generated in uplink in addition to the four standard mobile stations. In downlink, as many as 508 background channels (DPCHs) can be generated in addition to the four enhanced channels. 16 OCNS (orthogonal channel noise simulation) channels according to the 3GPP specification TS 25.241 can be generated upon a keystroke.
- Bit errors can be created and inserted into the data of the enhanced channels. In this way the internal BER testers of base or mobile stations can be checked for example.
- Block errors (BLERs) can be inserted into the channel-coded data.
- It is possible to generate WCDMA signals of up to 2 minutes repetition rate by combining standard channels (R&S SMIQB45) and en-

hanced channels (R&S SMIQB48) of different subsequence length.

## Arbitrary Waveform Generator R&S SMIQB60

To further enhance the versatility of the modulation coder, a dual-channel arbitrary waveform generator (ARB) with a maximum clock rate of 40 MHz is available as an option. It can store up to 512 ksamples of externally computed I/Q values.

The supplied R&S WinQSIM™ software allows the calculation of arbitrary modulation signals, for example COFDM, multicarrier and noise, and downloading them into R&S SMIQ. Together with a convenient data editor, R&S WinQSIM™ can calculate any kind of TDMA frame configuration, simulate impairments by superimposed interference signals, etc.

Note: The 512 ksample waveform memory cannot actually be compared with the relevant data of conventional ARB generators. In R&S SMIQB60, the oversampling needed for suppressing repetitive spectra by means of the analog filter

is effected automatically and in realtime by way of hardware interpolation. In this way, no waveforms created by oversampling have to be stored. With WCDMA, for example, this allows the storage of waveforms that would require 1.25 Msample output memory in the case of conventional ARB generation.

## Digital standard IS-95 with R&S SMIQ and options R&S SMIQK11 and R&S SMIQB60 (ARB)

In addition to generating IS-95 signals with option R&S SMIQB42, R&S SMIQ in conjunction with Arbitrary Waveform Generator R&S SMIQB60 now simulates CDMA signals to the North American standard IS-95A. Option R&S SMIQK11 enables IS-95 functionality under R&S WinQSIM™.

Up to eight complete base stations comprising 64 code channels each are available in forward link and up to 16 mobile stations in reverse link. The channel power can be set independently for all code channels.

Moreover, adjacent-channel power can be calculated for the first and the

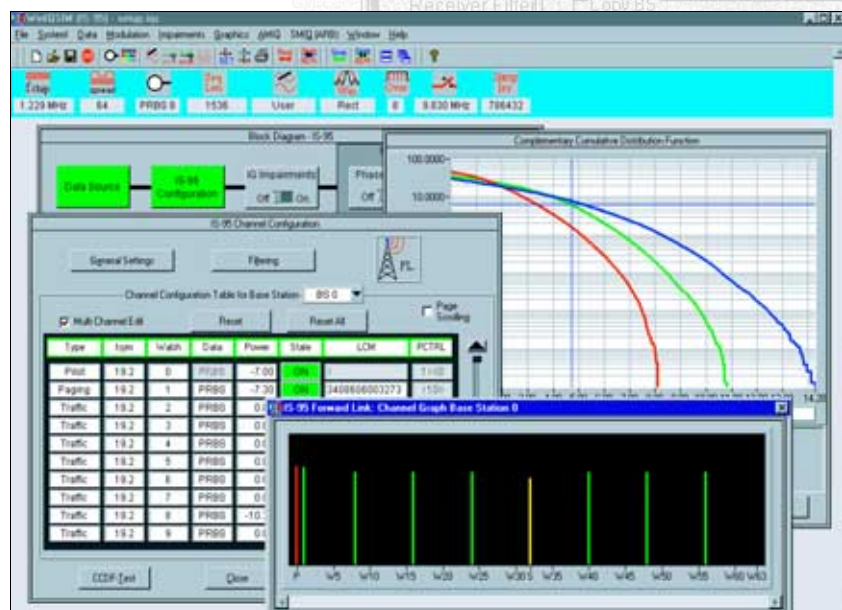

second adjacent channel and output as a spectral display. The CCDF trace too can be displayed.

**Digital standard cdma2000 with R&S SMIQ and options R&S SMIQ12 and R&S SMIQB60 (ARB)**

CDMA signals to the North American standard IS-2000 can be simulated by means of software option R&S SMIQ12 in conjunction with Arbitrary Waveform Generator R&S SMIQB60. Option R&S SMIQ12 enables cdma2000 functionality under R&S WinIQSIM™.

The modes 1X direct spread, 3X direct spread and 3X multicarrier (forward link only) are available. In forward link four base stations of max. 91 code channels can be set, in reverse link four mobile stations of max. 13 code channels each (irrespective of the radio configuration in each case).

In mode 1X, radio configurations RC 1 to RC 5 are available, in mode 3X RC 6 to RC 9.

Channel coding can be set for each base station and mobile station (selectable modes: coding off, coding complete, without interleaving, interleaving only).

R&S WinIQSIM™ enables graphic display of CCDF traces, channel graph, domain conflicts and code domain (the latter two only in forward link).

**Convenient operation with R&S WinIQSIM™ ...**

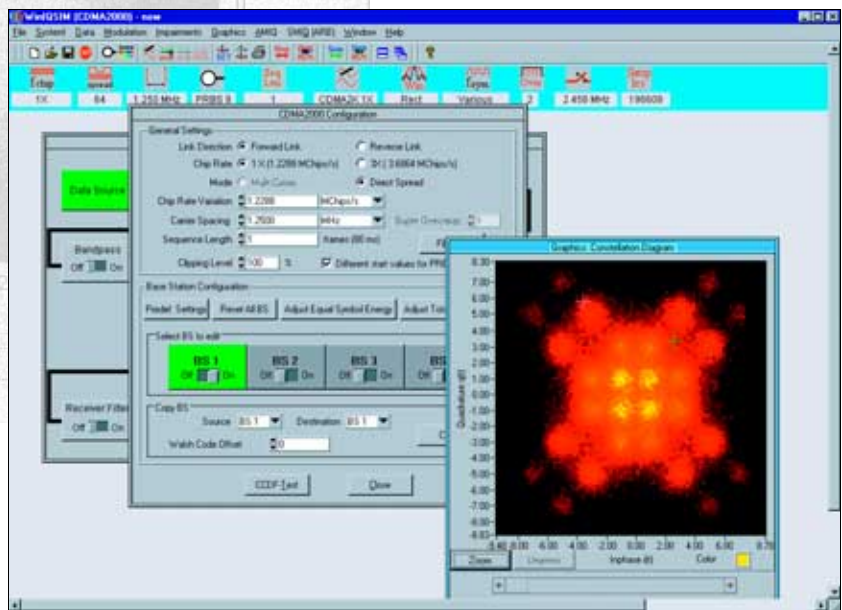

# Special options

## Fading simulation – options R&S SMIQB14/B15

With the optional fading simulator, the R&S SMIQ models are the first signal generators allowing tests that correspond to the capabilities of conventional simulators. Fading is thus no longer a matter of highly specialized measurement technology.

Fading simulation in R&S SMIQ is based on the WSSUS (wide sense stationary uncorrelated scattering) model and meets the test specifications of all main mobile radio standards, such as GSM Rec. 05.05. Both internal and external I/Q baseband signals are provided with defined multipath propagation factors through digital signal processing. Conversion to the RF with calibrated level setting is made with the available hardware of R&S SMIQ.

### 6-path fading with R&S SMIQB14

Option R&S SMIQB14 allows realistic simulation of a received signal that is composed of up to 6 propagation paths, irrespective of the selected modulation mode, with RF bandwidths of up to 14 MHz (3 dB).

Each of the 6 propagation paths can be individually parameterized in a wide range.

Rayleigh, Rice and lognormal fading profiles can be selected independently for each path. Likewise, attenuation, delay and speed can be set separately for each propagation path.

In addition to user configurations, pre-programmed settings in line with test specifications of mobile radio standards (GSM, NADC, IS-95 CDMA and TETRA) can be called at a key-stroke, which greatly facilitates operation.

## Why fading tests?

Short-time signal fading, as caused by multipath propagation, strongly affects the error rate of the received signal due to the short symbol periods in digital mobile radio

Modern digital systems overcome these problems with the aid of appropriate error control coding methods as well as algorithms for delay equalizing.

Interleaving is employed to overcome the problem of losing large parts of the messages.

Resistance to fading is an essential quality criterion of digital mobile radio systems and means a considerable competitive advantage for the manufacturer.

Tests with real-world signals using fading simulators are a must to spot the weak points in new concepts at an early stage so that appropriate modifications can be made.

Generating two correlated faded RF channels

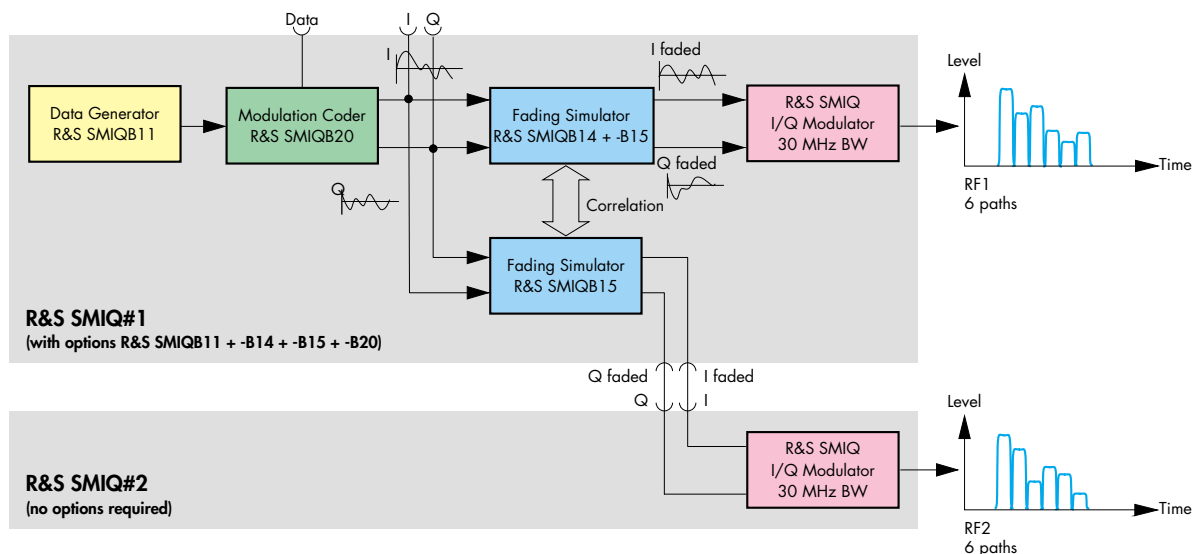



Typical Rayleigh fading profile

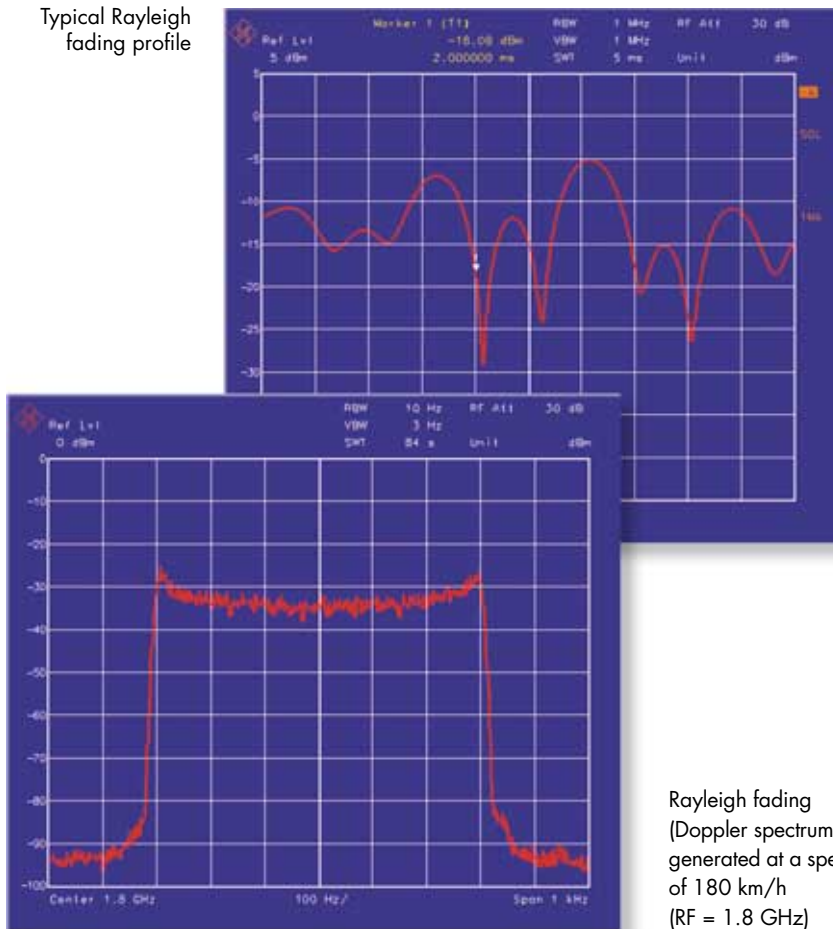

Rayleigh fading (Doppler spectrum), generated at a speed of 180 km/h (RF = 1.8 GHz)

### 12-path fading with R&S SMIQB15

Option R&S SMIQB15 provides another 6 paths for fading, which can be parameterized exactly as the first 6 paths, to give a total of 12 paths.

### 2-channel fading (6 paths per channel)

For testing base-station receivers with two separate antenna inputs (diversity), the I/Q output signals of options R&S SMIQB14 and -B15 can be separated in the (6+6)-path fading mode.

While the I/Q signals of the first fading simulator (option R&S SMIQB14) are used for driving the internal I/Q modulator, the second fading option (R&S SMIQB15) is used to feed a second vector signal generator. In this mode, the individual propagation paths of the two options can be correlated with each other one by one in pairs.

### Enhanced fading functions for WCDMA 3GPP with option R&S SMIQB49

R&S SMIQB49 extends the functionality of fading options R&S SMIQB14/B15 to include WCDMA 3GPP channel simulation. It adds three new modes to the fading simulator so that all scenarios defined in 3GPP Release 99 can be simulated:

## Advantages of the R&S SMIQ fading concept

- **Unrivalled price/performance ratio**

For the first time, fading in a quality corresponding to that of a high-grade simulator is available at a fraction of the costs previously involved.

- **Compact**

With this concept, neither external RF signals nor a LO signal are required to simulate fading, so that simulation is simply a compact one-box solution.

- **Versatile with calibrated output levels**

R&S SMIQ fading capability can be used without any restriction on the frequency and level range of the signal generator (-140 to -5 dBm). The user can define and store his own fading scenarios.

- **Easy to operate**

Preprogrammed settings in line with the test specifications of mobile radio standards can be recalled at a keystroke. Tests can be carried out easily and rapidly.

- In fine delay mode, fading simulator resolution is increased to 1 ns with up to four paths being available.
- In moving delay mode, two paths are simulated: for one path the delay remains constant, whereas for the other path the delay varies continuously.
- In birth-death mode, there are two paths changing delay in steps in accordance with the 3GPP channel model.

# Special options (continued)

## Noise generation and distortion simulation – R&S SMIQB17

### Real signals

A signal generator is normally used to generate as near as possible ideal signals. For testing receivers, it is however also necessary to simulate real transmitting and receiving conditions. This is exactly what option R&S SMIQB17 has been designed for.

### Noise generator

With the aid of the noise generator, an additive white Gaussian noise (AWGN) signal can be superimposed on the output signal of R&S SMIQ. The ratio of carrier power to noise power (C/N) can be varied with high resolution over a wide range. This allows for instance precise sensitivity measurement of receiver circuits with defined C/N.

### Distortion simulator

The distortion simulator allows simulation of amplitude and phase distortion (eg of a travelling wave tube in a satellite output stage). All that has to be done is to enter via the IEC/IEEE bus the input values of the AM/AM and AM/ $\phi$ M characteristics to be simulated. The complete characteristics forming the basis for nonlinear distortion of the I/Q baseband signals are calculated by means of spline interpolation. It is possible to distort I/Q signals irrespective of whether they are generated by the internal modulation coder or applied from an external source.

Digital signal processing in the baseband (I and Q signals) is used both for the generation of the AWGN signal and distortion of the output signal. This ensures high accuracy and excellent reproducibility of measurements.

### Versatile applications

Distortion simulation and additive noise can be combined with the following R&S SMIQ functions: vector modulation, digital modulation, digital standards and fading simulator.

### The method in detail

The distortion characteristics are internally represented by 2000 interpolation points which are determined by cubic spline interpolation from up to 30 input values. Several distortion characteristics can be stored under user-defined names and recalled. AM/AM and AM/ $\phi$ M distortion may also be defined by entering polynomial coefficients up to the fifth order.

Inverse polynomials can be selected for compensating the distortion of an external amplifier. The noise bandwidth can be varied in a wide range.

Constellation diagram of noisy QPSK signal

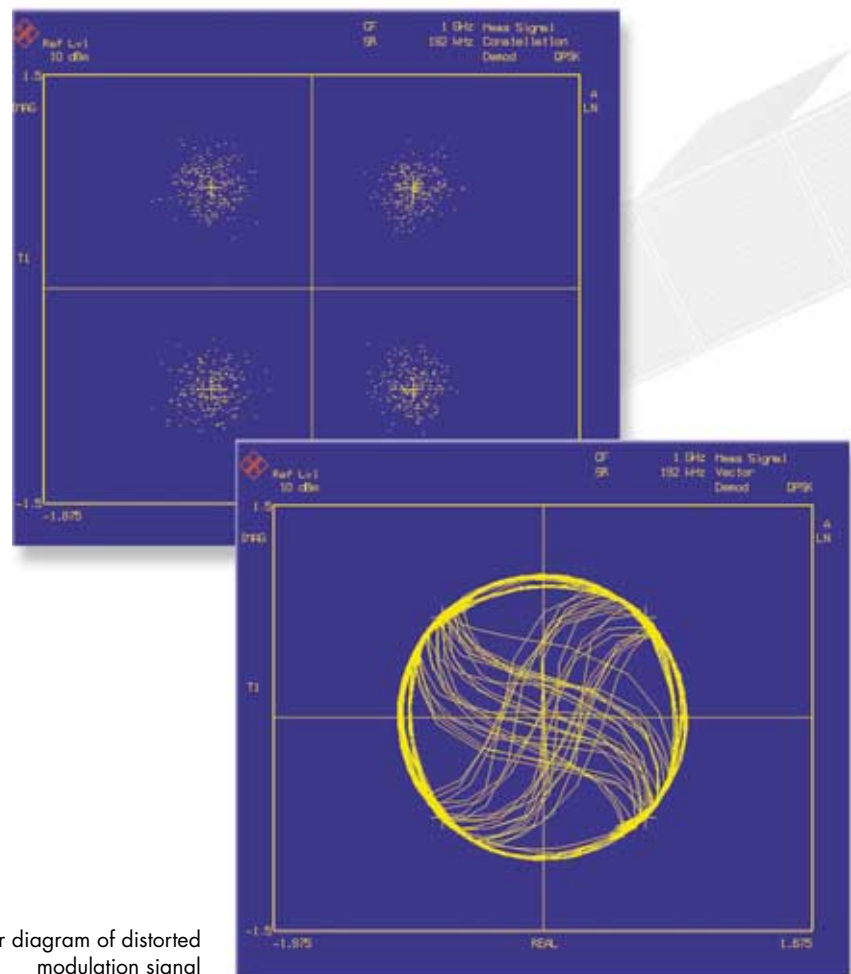

Vector diagram of distorted modulation signal

## Low ACP for IS-95 CDMA and WCDMA – R&S SMIQB47

### Challenging test requirements

Modern communications systems that are based on access methods like CDMA or WCDMA place demanding requirements on terminals and components.

For testing components (eg base-station power amplifier) that are used in such systems special test sources with outstanding characteristics regarding adjacent-channel power ratio (ACPR) are required. The measurement equipment used should cause as little interference as possible.

designed for IS-95 CDMA (1.2288 Mcps) and WCDMA (3.840 Mcps and 4.096 Mcps/8.192 Mcps respectively) and, with adjacent-channel power reduction, provides sufficient measurement margin for characterizing and testing components (eg amplifiers).

The adjacent-channel power ratio for a WCDMA signal with one DTCH (dedicated traffic channel) is typically  $-67$  dBc<sup>1)</sup>. For IS-95 CDMA the typical adjacent-channel power ratio is  $-78$  dBc<sup>2)</sup>.

Option R&S SMIQB47 can be used both with internal signals of the modulation coder (R&S SMIQB20) or with an external I/Q source (eg R&S AMIQ).

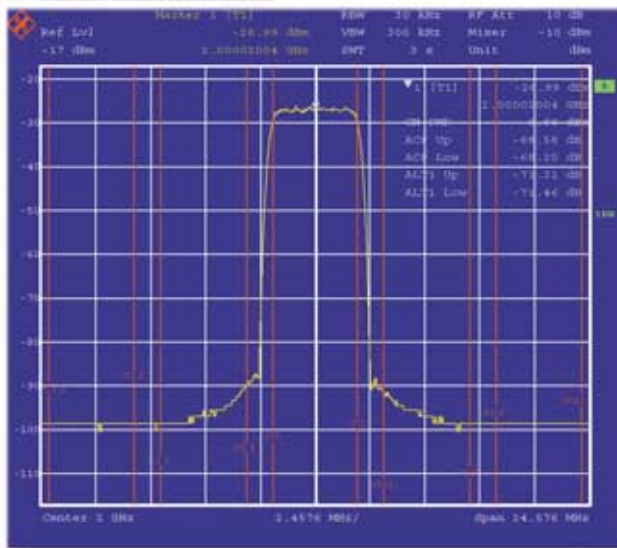

ACP measurement for a WCDMA signal with option R&S SMIQB47

### ACPR – unrivalled low

The extraordinarily low ACPR of the basic R&S SMIQ unit is made possible by the built-in high-grade I/Q modulator. In conjunction with option R&S SMIQB47 providing additional filtering in the I/Q signal path, R&S SMIQ becomes an ideal signal source suited to meet the most stringent requirements. This option has especially been

- 1) 3.84 MHz bandwidth, 5 MHz offset, 2.5 MHz I/Q filter
- 2) 9 channels, 885 kHz offset, 850 kHz I/Q filter

## Fast CPU

### Fit for production

Time is money! R&S SMIQ is equipped with a fast CPU for applications in production where complete test runs should take no more than a few seconds.

This CPU reduces the standard setting times for frequency and level to 3 ms (without switching the mechanical attenuators) to provide maximum throughput and so ensures competitiveness and economy of the production line.

## BER measurement – R&S SMIQB21

Measuring the bit error rate has become a frequently used method for the verification of digital communication systems (eg measuring the sensitivity or selectivity of receivers, subsystems and components). The retrofitable option (R&S SMIQB21) allows R&S SMIQ to be used for these BER (bit-error-rate) measurements. The device under test (DUT) has to deliver the data to be tested and the associated clock. If the DUT does not have its own clock, it can be generated by R&S SMIQ and output via bit and/or symbol clock. The built-in BER tester compares these data with the nominal data and calculates the error rate. Various standard PRBS sequences (PN9, PN15, etc) are used as nominal data. The result of the BER measurement is also available via the remote-control interface.

# Applications

## **Type-approval testing of digital base and mobile stations**

Mobile and base stations are complex systems, where signal generators are used for testing out system parts such as receivers, modulators and amplifiers. Due to its versatility and signal quality, R&S SMIQ is ideally suited to handle these tasks.

## **Sensitivity measurements on digital receivers**

Sensitivity measurements on digital receivers require high modulation quality as well as precise level setting over a wide range.

Due to the losses in automatic test systems – caused by cables and the use of power splitters, relays, attenuators,

etc – the absolute level accuracy is less important than the reproducibility of the settings. R&S SMIQ yields excellent values in this respect.

Frame structures with defined data contents for BER measurements are made available by programmed standard settings.

## **Selectivity measurements on digital receivers**

Low phase and broadband noise, high spurious suppression of >70 dB even with activated digital modulation as well as excellent adjacent-channel power ratios make R&S SMIQ an ideal source for selectivity measurements on digital receivers.

## **Base-station transmitter test**

For testing base-station transmitters, R&S SMIQ is able to supply the data signals of the internal data generator (DATA, DATA CLK, SYMB CLK) as well as the analog I/Q baseband signals.

## **Testing of equalizers**

The optional fading simulator for R&S SMIQ is ideal for testing the equalizers of digital receivers. While conventional fading simulators need external RF input signals, R&S SMIQ generates its own modulated RF signal. New equalizer concepts can thus be tested at a very early stage in development.

## **Tolerance tests on digital systems**

In addition to ideal signals, R&S SMIQ also allows the generation of signals

R&S SMIQ in TETRA simulator





Module test with  
R&S SMIQ, R&S  
AMIQ and  
Signal Analyzer  
R&S FSIQ

with defined degradations (I/Q impairments or noise and distortion with option R&S SMIQB17) as well as the variation of bit rates and filtering to determine tolerance limits and to detect potential critical spots in new systems.

#### Components tests

The high setting speed and modulation quality make R&S SMIQ supreme for use in the development and production of digital components and modules.

The high intermodulation suppression of the I/Q modulator of R&S SMIQ ensures excellent adjacent-channel power ratios of the modulated output signal for conclusive linearity measurements on amplifier components.

The high spurious suppression of >70 dB of the R&S SMIQ output signal allows accurate measurements on mixer components.

#### Development of new digital communication systems

R&S SMIQ offers all capabilities that are required for developing new digital communication systems.

Featuring a modulation bandwidth of 30 MHz (-3 dB), the I/Q modulator of R&S SMIQ is ideal for future broadband systems.

The optional modulation coder allows any digital modulation modes – from BPSK through to 256QAM – to be generated with variable data rate and baseband filtering.

With the maximum symbol rate of 18 Msymbol/s broadband digital modulation modes can be generated. Any TDMA structures can be produced with the aid of a programmable burst generator.

The modulation coder of R&S SMIQ is already equipped for future applications, eg in the field of broadband spread-spectrum systems (wireless local loop, wireless LAN).

R&S SMIQ meets already today the challenges of tomorrow's market.

## Ordering information

### Vector Signal Generator

R&S SMIQ02B (300 kHz to 2.2 GHz)	1125.5555.02
R&S SMIQ03B (300 kHz to 3.3 GHz)	1125.5555.03
R&S SMIQ04B (300 kHz to 4.4 GHz)	1125.5555.04
R&S SMIQ06B (300 kHz to 6.4 GHz)	1125.5555.06

### Accessories supplied

power cable, operating manual

### Options

Reference Oscillator OCXO	R&S SM-B1	1036.7599.02
FM/φM Modulator	R&S SM-B5	1036.8489.02
Data Generator	R&S SMIQB11	1085.4502.04
Memory Extension, 32 Mbit	R&S SMIQB12	1085.2800.04
Fading Simulator, 6 paths	R&S SMIQB14	1085.4002.02
Second Fading Simulator for 12 paths or 2 channels	R&S SMIQB15	1085.4402.02
Noise Generator and Distortion Simulator	R&S SMIQB17	1104.9000.02
RF and AF Rear Connectors	R&S SMIQB19	1085.2997.02
Modulation Coder	R&S SMIQB20	1125.5190.02
BER Measurement	R&S SMIQB21	1125.5490.02
Digital Standard IS-95 CDMA	R&S SMIQB42	1104.7936.02
Digital Standard WCDMA acc. to NTT DoCoMo 1.0, ARIB 0.0 standard	R&S SMIQB43	1104.8032.02
Digital Standard WCDMA acc. to 3GPP (FDD)	R&S SMIQB45	1104.8232.02
Low ACP for IS-95 CDMA and WCDMA	R&S SMIQB47	1125.5090.02
Modification Kit for Low ACP (factory installation only)	R&S SMIQU47	1125.5149.02
Extended Functions for WCDMA (3GPP)	R&S SMIQB48	1105.0587.02
Extended Fading Functions for WCDMA (3GPP)	R&S SMIQB49	1105.1083.02
Arbitrary Waveform Generator incl. R&S WinIQSIM™	R&S SMIQB60	1136.4390.02
TETRA T1 Simulator	R&S SMIQ-K8	1136.4290.02
Digital Standard IS-95 CDMA (for option R&S SMIQB60)	R&S SMIQK11	1105.0287.02
Digital Standard cdma2000 (for option R&S SMIQB60)	R&S SMIQK12	1105.0435.02
Digital Standard WCDMA TDD Mode (3GPP) (for option R&S SMIQB60)	R&S SMIQK13	1105.1231.02
Digital Standard TD-SCDMA (for option R&S SMIQB60)	R&S SMIQK14	1105.1383.02
OFDM Signal Generation, HIPERLAN/2 (for option R&S SMIQB60)	R&S SMIQK15	1105.1531.02
Digital Standard IEEE 802.11b (for option R&S SMIQB60)	R&S SMIQK16	1154.7700.02
Digital Standard 1xEV-DO (for option R&S SMIQB60)	R&S SMIQK17	1154.7800.02
Digital Standard IEEE 802.11a (for option R&S SMIQB60)	R&S SMIQK18	1154.7952.02

Additional hint: R&S SMIQ02B/03B (R&S SMIQ04B/06B) can be equipped with up to three (two) of the following options: R&S SMIQ-B5, R&S SMIQB14, R&S SMIQB15, R&S SMIQB17

### Application software

PC Software: Generation of data and control lists	R&S SMIQ-K1	*)
PC Software: Bluetooth signals for R&S SMIQ	R&S SMIQ-K5	*)
PC Software: User mappings and user filters for R&S SMIQ	R&S User Mod	*)

\*) available at [www.rohde-schwarz.com](http://www.rohde-schwarz.com)

### Recommended extras

19" Adapter	R&S ZZA-94	0396.4905.00
Service Kit	R&S SM-Z3	1085.2500.02
BNC Adapter for rear panel, D type connector PAR DATA	R&S SMIQ-Z5	1104.8555.02
90° Power Splitter	R&S SMIQ-Z9	1104.9580.02
Trolley for Transit Case	R&S ZZK-1	1014.0510.00
Transit Case	R&S ZZK-944	1013.9366.00
Service Manual R&S SMIQ		1085.2445.24

### Instrument upgrades

R&S SMIQ02B to R&S SMIQ03B	R&S SMIQU03	1125.5855.03
R&S SMIQ03B to R&S SMIQ04B	R&S SMIQU04	1125.5855.04
R&S SMIQ04B to R&S SMIQ06B	R&S SMIQU06	1125.5855.06

For specifications see separate data sheet (enclosed)

Certified Quality System  
**ISO 9001**  
DQS REG. NO 1954

Certified Environmental System  
**ISO 14001**  
REG. NO 1954



**ROHDE & SCHWARZ**

READY FOR  
**WCDMA**



## Specifications for Vector Signal Generator R&S SMIQ

Valid from 7/2002

Specifications are guaranteed under the following conditions: 30 minutes warmup time at ambient temperature, specified environmental conditions met, calibration cycle adhered to, and total calibration performed. Data designed „overrange“ are not guaranteed. Data without tolerances: typical values. – In compliance with the 3GPP standard, chip rates are specified in Mcps (million chips per second), whereas bit rates, symbol rates and sample rates are specified in kbps (thousand bits per second) or kspss (thousand symbols/samples per second). Mcps, kbps and kspss are not SI units.

## RF features

### Frequency

<b>Range</b>	
R&S SMIQ02B	300 kHz to 2.2 GHz
R&S SMIQ03B	300 kHz to 3.3 GHz
R&S SMIQ04B	300 kHz to 4.4 GHz
R&S SMIQ06B	300 kHz to 6.4 GHz
<b>Resolution</b> (CW, analog modulation, attenuator mode AUTO)	0.1 Hz
Setting time to within $<1 \times 10^{-7}$ for $f > 450$ MHz and $<240$ Hz for $f < 450$ MHz after IEC/IEEE-bus delimiter with ALC MODE set to ON or ALC OFF MODE set to TABLE	
Normal operation	
$f \leq 3.3$ GHz	$<3$ ms
$f > 3.3$ GHz	$<3.3$ ms
After trigger pulse in list mode	
$f \leq 3.3$ GHz	$<500$ $\mu$ s
$f > 3.3$ GHz	$<700$ $\mu$ s
Fast restore mode	
$f \leq 3.3$ GHz	$<800$ $\mu$ s
$f > 3.3$ GHz	$<1$ ms
Phase offset	adjustable in steps of $0.1^\circ$

### Reference frequency

	Standard	Option R&S SM-B1
Aging (after 30 days of operation)	$1 \times 10^{-6}$ /year	$<1 \times 10^{-9}$ /day
Temperature effect ( $0^\circ\text{C}$ to $50^\circ\text{C}$ )	$2 \times 10^{-6}$	$<5 \times 10^{-8}$
Warm-up time		$\leq 15$ min
Output for internal reference		
Frequency		10 MHz
Level		8 dBm
Source impedance		$50 \Omega$
Input for external reference		
Frequency	1 MHz to 16 MHz in 1 MHz steps	
Permissible frequency drift	$3 \times 10^{-6}$	
Input level	0.1 V to 2 V rms	
Input impedance	$200 \Omega$	
Electronic tuning (EXT. TUNE)	$1 \times 10^{-7}$ /V	values to standard,
Input voltage range	0 V to $\pm 10$ V	but with Adjustment
Input impedance	$10 \text{ k}\Omega$	State On

### Level

<b>Range</b>	
R&S SMIQ02B/03B	$-144$ dBm to $+13$ dBm (PEP) <sup>1)</sup>
R&S SMIQ04B/06B	$-144$ dBm to $+10$ dBm (PEP) <sup>1)</sup>
Overranging without guarantee of specs	up to $16$ dBm
Resolution (CW, FM, $\phi$ M, attenuator mode AUTO)	$0.1$ dB or $0.01$ dB



Total level uncertainty $>-127$ dBm <sup>2) 12)</sup> , CW		
f $\leq 2.5$ GHz	<0.5 dB	
f >2.5 GHz to 4 GHz	<0.9 dB	
f >4 GHz to 6.4 GHz	<1.2 dB	
Output impedance	50 $\Omega$	
VSWR	f $\leq 2.2$ GHz	2.2 GHz < f $\leq 6.4$ GHz
	max. level	<2.0
$\leq -3$ dBm	<1.8	<1.8
Setting time to within 0.1 dB from settled level after IEC/IEEE bus delimiter in CW, FM, $\phi$ M	<25 ms with mechanical attenuator	
	<2.5 ms without mechanical attenuator	
Non-interrupting level setting		
FIXED mode	setting range >20 dB	
ELECTRONIC mode	setting range >80 dB	
Overload protection	protects the unit from externally applied RF power (from 50 $\Omega$ source) and DC voltage	
Max. permissible RF power	50 W (R&S SMIQ02B/R&S SMIQ03B)	
	1 W (R&S SMIQ04B/R&S SMIQ06B)	
Max. permissible DC voltage	35 V (R&S SMIQ02B/R&S SMIQ03B)	
	0 V (R&S SMIQ04B/R&S SMIQ06B)	

## Spectral purity <sup>2)</sup>

Spurious		
Harmonics	at levels $\leq 10$ dBm (R&S SMIQ02B/03B) at levels $\leq 7$ dBm (R&S SMIQ04B/06B)	<-30 dBc
Nonharmonics		
CW, carrier offset >10 kHz		
0.3 MHz to 450 MHz		<-74 dBc
>450 MHz to 1500 MHz		<-80 dBc
>1500 MHz to 3000 MHz		<-74 dBc
>3000 MHz to 3300 MHz		<-60 dBc
>3300 MHz		as with vector modulation
Vector modulation,		
carrier offset 10 kHz to < 300 MHz		
0.3 MHz to 3300 MHz		<-70 dBc
carrier offset $\geq 300$ MHz		
0.3 MHz to 3300 MHz		<-60 dBc
carrier offset 10 kHz to < 900 MHz		
>3300 MHz to 6000 MHz		<-64 dBc
>6000 MHz		<-58 dBc
carrier offset $\geq 900$ MHz		
>3300 MHz, $\geq 5$ dBm		<-50 dBc
Broadband noise, CW, carrier offset >5 MHz, measurement bandwidth 1 Hz		
f >20 MHz to 450 MHz		<-136 dBc (-142 dBc typ.)
f >450 MHz to 3040 MHz		<-138 dBc (-144 dBc typ.)
f >3040 MHz to 3300 MHz		<-136 dBc (-142 dBc typ.)
f >3300 MHz to 6400 MHz		<-132 dBc (-138 dBc typ.)
Broadband noise, vector modulation,		
f >20 MHz, carrier offset >5 MHz to 3300 MHz		<-136 dBc (-140 dBc typ.)
f >20 MHz, carrier offset >3300 MHz to 6400 MHz		<-133 dBc (-137 dBc typ.)
SSB phase noise, carrier offset 20 kHz, measurement bandwidth 1 Hz		
	CW	Vector/dig. mod.
f = 20 MHz to 450 MHz	<-116 dBc	<-119 dBc
f = 1 GHz	<-126 dBc	<-123 dBc
f = 2 GHz	<-120 dBc	<-120 dBc
f = 3 GHz	<-116 dBc	<-116 dBc
f = 6 GHz	<-110 dBc	<-110 dBc

Residual FM, rms (f = 1 GHz)	
0.3 kHz to 3 kHz (ITU-T)	<1 Hz
0.02 kHz to 23 kHz	<4 Hz
Residual AM, rms (0.02 kHz to 23 kHz)	<0.02%

## Sweep

RF sweep, AF sweep	digital sweep in discrete steps
Modes	automatic, single shot, manual or external trigger, linear or logarithmic
Sweep range	user-selectable
Step width (lin)	user-selectable
Step width (log)	0.01% to 100%
Level sweep	not available with vector or digital modulation
Modes	automatic, single shot, manual or external trigger, logarithmic
Sweep range	0.1 dB to 20 dB
Step width (log)	0.1 dB to 20 dB
Step time	3 ms to 5 s
Resolution	0.1 ms
Markers	3, user-selectable
MARKER output signal	TTL level (HCT), selectable polarity
X output	0 V to 10 V
BLANK output signal	TTL level (HCT), selectable polarity

## Internal modulation generator

Frequency range	0.1 Hz to 1 MHz
Resolution	0.1 Hz
Frequency error	$<(1 \times 10^{-4} \text{ of setting} + 0.012 \text{ Hz})$
Frequency response up to 100 kHz	<0.4 dB
Frequency response up to 1 MHz	<2 dB
Distortion up to 100 kHz ( $R_L > 200 \Omega$ , peak level 1 V)	<0.2%
Open-circuit voltage at LF socket	1 mV to 4 V peak
Resolution	1 mV
Setting error at 1 kHz	1% + 1 mV
Output impedance	approx. 10 $\Omega$
Frequency setting time (after receiving last IEC/IEEE-bus character)	<3 ms

## Analog modulation

### Vector modulation

Level accuracy with vector modulation, additional error with ALC OFF, relative to CW	<0.3 dB
Mode	external DC
I and Q modulation inputs	
Input impedance	50 $\Omega$
VSWR (DC to 30 MHz)	<1.2
If R&S SMIQ is fitted with <b>two</b> fading simulators (R&S SMIQB14 and R&S SMIQB15) <b>and</b> a noise generator and distortion simulator (R&S SMIQB17), the VSWR of the I and Q inputs for vector modulation (DC to 30 MHz) degrades to	<1.25
Input voltage for full-scale input	$\sqrt{I^2 + Q^2} = 0.5 \text{ V}$ (1 V EMF with 50 $\Omega$ source)
<b>Static error vector</b> <sup>3)</sup>	
level $\leq 8$ dBm PEP (R&S SMIQ02B/03B)	
level $\leq 5$ dBm PEP (R&S SMIQ04B/06B)	
up to 3.3 GHz	
rms value	<0.5%
peak value	<1%
>3.3 GHz	
rms value	<1%
peak value	<2%
<b>Modulation frequency response</b>	
up to 5 MHz	<0.4 dB
up to 30 MHz	<3 dB
Carrier leakage at 0 V input voltage, referred to full-scale input <sup>3)</sup>	<-45 dBc
<b>I/Q impairments</b>	
Carrier leakage	
Setting range	0% to 50%
Resolution	0.5%
I $\neq$ Q	
Setting range	-12% to +12%
Resolution	0.1%
Quadrature offset	
Setting range	-10° to +10°
Resolution	0.1°
<b>Envelope control</b>	
RF level can be controlled with an analog voltage of 0 V to 1 V via the POWER RAMP input	1 V: set level 0 V: maximum level attenuation
Input impedance	10 k $\Omega$
Linear range	0 dB to -30 dB (-35 dB typ.)
Attenuation error at -20 dB	<0.5 dB
On/off ratio	>80 dB
Delay time	1 $\mu$ s typ.
Rise/fall time (10% to 90%)	<1 $\mu$ s

## Amplitude modulation <sup>2)</sup>

Modes	internal, external AC/DC
Modulation depth	0% to 100%
Resolution	0.1%
Setting error at 1 kHz (m < 80%)	<4% of reading + 1%
<b>AM distortion at 1 kHz</b>	
m = 30%	<1%
m = 80%	<2%
Modulation frequency range, RF ≥ 5 MHz for RF < 5 MHz	DC to 50 kHz DC to 3 kHz
<b>Modulation frequency response</b>	
20 Hz to 20 kHz for RF < 5 MHz, 20 Hz to 3 kHz	<3 dB <3 dB
<b>Incidental φM at 30% AM,</b> AF = 1 kHz, peak value	
	<0.1 rad
<b>Modulation input EXT1</b>	
Input impedance	>100 kΩ
Input voltage for selected modulation depth	1 V peak
High/low indication (10 Hz to 50 kHz)	for inaccuracy >3%

## Broadband amplitude modulation

Mode	external DC
<b>Modulation frequency response</b>	
up to 10 MHz	<1 dB
up to 30 MHz	<3 dB
<b>Modulation input (broadband AM)</b>	
Input impedance	50 Ω
Input voltage for 100% AM	0.25 V peak

## Pulse modulation

Modes	external
On/off ratio	>80 dB
Rise/fall time (10%/90%)	30 ns typ.
Pulse repetition frequency	0 kHz to 1 MHz
Pulse delay	200 ns typ.
<b>Modulation input PULSE</b>	
Input signal	TTL level (HCT)
Input impedance	>10 kΩ

## Frequency modulation with option R&S SM-B5

Modes	internal, external AC/DC, two-tone with two modulation channels FM1 and FM2
<b>Max. deviation without I/Q modulation</b>	
0.3 MHz to 450 MHz	2 MHz
>450 MHz to 750 MHz	0.5 MHz
>750 MHz to 1500 MHz	1 MHz
>1500 MHz to 3300 MHz	2 MHz
>3300 MHz to 6400 MHz	4 MHz

Max. deviation with I/Q modulation	
0.3 MHz to 750 MHz	2 MHz
>750 MHz to 1200 MHz	1 MHz
>1200 MHz to 3300 MHz	2 MHz
>3300 MHz to 6400 MHz	4 MHz
Resolution	<1%, min. 10 Hz
Setting error at AF = 1 kHz	<(3% of setting + 20 Hz)
FM distortion at AF = 1 kHz and half maximum deviation	<0.5%
Modulation frequency range with maximum deviation	DC to 500 kHz
at <25% of maximum deviation	DC to 2 MHz
Modulation frequency response	
10 Hz to 100 kHz	<0.5 dB
10 Hz to 2 MHz	<3 dB
Incidental AM at 40 kHz deviation, AF = 1 kHz, carrier frequency >5 MHz	<0.1%
Carrier frequency offset with FM	<0.01% of maximum deviation +1% of selected deviation
EXT1, EXT2 modulation inputs	
Input impedance	>100 k $\Omega$
Input voltage for selected modulation depth	1 V peak
High/low indication (10 Hz to 100 kHz)	for inaccuracy >3%

### Phase modulation with option R&S SM-B5<sup>13)</sup>

Modes	internal, external AC/DC, two-tone with two modulation channels PM1 and PM2
Max. deviation without I/Q modulation	
0.3 MHz to 450 MHz	20 rad
>450 MHz to 750 MHz	5 rad
>750 MHz to 1500 MHz	10 rad
>1500 MHz to 3300 MHz	20 rad
>3300 MHz to 6400 MHz	40 rad
Max. deviation with I/Q modulation	
0.3 MHz to 750 MHz	20 rad
>750 MHz to 1200 MHz	10 rad
>1200 MHz to 3300 MHz	20 rad
>3300 MHz to 6400 MHz	40 rad
Resolution	<1%, min. 0.001 rad
Setting error at AF = 1 kHz	<3% of reading + 0.01 rad
Distortion at AF = 1 kHz and half maximum deviation	<1%
Modulation frequency range	DC to 100 kHz
Modulation frequency response	
10 Hz to 100 kHz	<0.8 dB
EXT1, EXT2 modulation inputs	
Input impedance	>100 k $\Omega$
Input voltage for selected modulation depth	1 V peak
High/low indication (10 Hz to 100 kHz)	for inaccuracy >3%

## Digital modulation

### Digital modulation with optional Modulation Coder R&S SMIQB20

Modes	internal, external serial, external parallel
Predefined modulation settings	APCO C4FM, APCO CQPSK, CDPD, CT2, DECT, GSM, IRIDIUM, NADC, PDC, PHS, TETRA, TETS, PWT, ICO BPSK, ICO GMSK, ICO QPSK, GSM EDGE, CDMA IS-95, WCDMA, QPSK
Internal PRBS	selectable lengths: $2^9-1$ , $2^{15}-1$ , $2^{16}-1$ , $2^{20}-1$ , $2^{21}-1$ and $2^{23}-1$
I/Q bandwidth	12 MHz
Modulation specifications apply at levels $\leq 8$ dBm (PEP) with R&S SMIQ02B/03B and at levels $\leq 5$ dBm (PEP) with R&S SMIQ04B/06B	
Total level uncertainty at levels $> -127$ dBm with digital modulation, crest factor $< 20$ dB <sup>2) 3)</sup>	
f $\leq 2,5$ GHz	$< 0.7$ dB
f $> 2,5$ GHz to 4 GHz	$< 1.2$ dB
f $> 4$ GHz	$< 1.5$ dB
For best short time repeatability use ALL OFF mode table	
<b>Clock generation</b>	
Clock mode	internal or external
Resolution	0.001 Hz
Error	$< 2^{-42}$ , related to reference frequency
<b>Inputs</b>	
DATA, BIT CLOCK, SYMBOL CLOCK, PAR DATA	
Serial data are taken from BNC connectors, parallel data (symbols) from rear PAR DATA connector. Parallel symbols may contain 1 to 8 bits and read in using an internal or external clock signal	
Trigger threshold	$-2.5$ V to $+2.5$ V, selectable, resolution 0.01 V
Input impedance	1 k $\Omega$ to ground, 50 $\Omega$ to ground
Max. data rate, serial	30 MHz, 50 MHz typ.
Max. symbol rate, parallel	18 MHz
<b>Outputs</b>	
DATA, BIT CLOCK, SYMBOL CLOCK, PAR DATA, (all TTL levels)	
I and Q baseband signals, output voltage, EMF, peak value	$\sqrt{I^2 + Q^2} = 1$ V
Power ramp	
Output voltage	0 V to 1 V
Output impedance	10 $\Omega$
<b>Level attenuation</b>	
via LEV ATT input	
Range	0 dB to 70 dB
Additional level error caused by attenuation <sup>3)</sup>	$< 1$ dB (up to 35 dB), $< 1.5$ dB (up to 70 dB)
<b>Envelope control</b>	
Modes	
Analog	External via POWER RAMP input (for data see vector modulation above). With an internal power ramp, the connector serves as an output.
Digital	Internal or external via BURST GATE input/output (PAR DATA connector). The BURST GATE input triggers a power ramp (TTL levels). The low/high transition starts the ramp function from blanking level to maximum level, the high/low transition from maximum level to blanking level. With an internal power ramp, the connector serves as an output.
Operating range	1 kHz to 2.5 MHz
Rise/fall time	
Setting range	0.25 symbols to 32 symbols
Resolution	1/4 symbol
Minimum time	1 $\mu$ s
<b>Modulation modes</b>	ASK, FSK, GMSK, PSK, QAM

<b>Baseband filter</b> Each filter can be used with any type of modulation. Exception: GMSK/GFSK only with Gaussian baseband filter	$\sqrt{\cos}$ ( $\alpha = 0.1$ to $0.99$ ), $\cos$ ( $\alpha = 0.1$ to $0.99$ ), resolution 0.01 Gauss, B x T = 0.15 to 2.5, resolution 0.01 GaussLin, B x T = 0.3 Bessel, B x T = 1.25 and 2.5/ IS-95 with or without equalizer / special filter for WCDMA, APCO C4FM / special filter for TETRA / split phase, B x T = 0.15 to 2.5 / rectangular
Filter modes	low EVM: for minimum error vector low ACP: for minimum adjacent-channel power
<b>ASK</b>	
Symbol rate	100 Hz to 18 MHz <sup>11)</sup> , max. 5 MHz
Modulation depth	0% to 100%
<b>FSK</b>	
Modulation modes	2FSK, 4FSK, 4FSK APCO, GFSK
Symbol rate	100 Hz to 7.5 MHz <sup>11)</sup>
Shift	$(0.1$ to $100) \times f_{\text{symp}}$ , max. 5 MHz
Resolution	<0.5%
Deviation error, rms value for shift 200 Hz to 650 kHz, symbol rate <1.3 Msymbol/s, filter $\sqrt{\cos}$ or $\cos$ with $\alpha = 0.25$ to 0.7 or Gauss with B x T = 0.2 to 0.7	<1.3%
<b>GMSK</b>	
Bit rate	100 Hz to 7.5 MHz <sup>11)</sup>
Modulation phase error with PRBS data, up to 1 Mbit/s, rms value	<1°
Peak value	<3°
<b>PSK</b>	
Modulation modes	BPSK, QPSK, OQPSK, QPSK (IS-95), OQPSK (IS-95), QPSK (ICO), QPSK (INMARSAT), $\pi/4$ DQPSK, $\pi/4$ QPSK, 8PSK, 8PSK EDGE
Symbol rate	100 Hz to 18 MHz <sup>11)</sup>
Error vector magnitude, rms for filter $\sqrt{\cos}$ , $\cos$ , IS-95, WCDMA	
up to 200 ksymbol/s, $\alpha \geq 0.25$	<1.2%
up to 1.5 Msymbol/s, $\alpha \geq 0.25$	<2%
up to 3 Msymbol/s, $\alpha \geq 0.25$	<3%
>3 Msymbol/s, $\alpha \geq 0.25$	typ. <3%
<b>TETRA ACP</b>	
f = (380 to 470) MHz, (915 to 988) MHz, level $\leq 8$ dBm PEP, low distortion output mode	
Offset 25 kHz	$\leq -71$ dB, $-74$ dB typ.
Offset 50 kHz	$\leq -76$ dB, $-80$ dB typ.
<b>QAM</b>	
Modulation modes	16QAM, 32QAM, 64QAM, 256QAM
Symbol rate	100 Hz to 18 MHz <sup>11)</sup>
Error vector magnitude, rms with 16QAM for filter $\sqrt{\cos}$ , $\cos$ , IS-95, WCDMA	<2%
up to 1 Msymbol/s, $\alpha \geq 0.25$	<3%
up to 3 Msymbol/s, $\alpha \geq 0.25$	<3% typ.
>3 Msymbol/s, $\alpha \geq 0.25$	

<b>User mapping</b>	via IEEE bus with software User Mod
Modulation modes	PSK, QAM, FSK
Modulation symbols	1 to 8 bit per symbol
Coding	differential, phase offset (PSK)
Range of symbol rate	like PSK, QAM and FSK
<b>User baseband filter</b>	via IEEE bus with software User Mod
Impulse length	8 or 16 symbols long
Oversampling	3 to 32
<b>Modulation coding</b>	differential coding, differential and Gray, GSM, NADC, TETRA, TETS, PDC, PHS, differential phase coding, APCO25, PWT, INMARSAT, VDL

## Modulation with coding

The table below shows the possible combinations of modulation with coding (X = combination possible).

	Coding off	Differential	Differential phase	Differential + Gray	GSM	NADC,PDC,PHS, TETRA,APCO25, PWT	TETS/TETRA	INMARSAT	VDL
ASK	X	X		X					
BPSK	X	X		X					
QPSK	X	X		X				X	
QPSK (IS-95)	X	X		X				X	
INMARSAT	X	X		X				X	
QPSK ICO	X	X		X				X	
OQPSK	X	X		X				X	
OQPSK (IS-95)	X	X		X				X	
$\pi/4$ QPSK	X								
$\pi/4$ DQPSK	X					X	X		
8PSK	X	X		X					X
8PSK_EDGE	X	X		X					X
2FSK	X	X		X	X				
4FSK, 4FSK APCO	X	X		X					
GFSK	X	X		X	X				
GMSK	X	X		X	X				
16QAM	X	X	X	X					
32QAM	X	X	X	X					
64QAM	X	X	X	X					
256QAM	X		X						

## Data generator (option R&S SMIQB11)

Programmable data memory for modulation data, envelope-control and trigger signals. The data generator can be operated only in conjunction with the optional modulation coder (R&S SMIQB20).

Memory capacity	15 Mbit
Max. symbol rate	8.5 MHz
Modes	automatically repeating, single shot, manually or externally triggered



<b>Inputs</b>	
Trigger input TRIGIN	for starting the data sequences in the data memory
Trigger frequency	<10 kHz
Selectable trigger delay	0 to $2^{16}-1$ symbols
Selectable trigger suppression	0 to $2^{26}-1$ symbols after trigger
Switching threshold	-2.5 V to 2.5 V, selectable, resolution 0.1 V
Input impedance	1 k $\Omega$ to ground, 50 $\Omega$ to ground
Required pulse width	>50 ns
<b>Outputs</b>	
DATA modulation data	see data under "Digital Modulation"
BURST GATE, LEV ATT	control signals for envelope control and level attenuation
CW	control signal for switching off digital modulation
TRIGOUT 1, TRIGOUT 2	user-programmable trigger signals
TRIGOUT 3	trigger signal on event
HOP	control signal for frequency hopping in LIST MODE

### Memory extension (option R&S SMIQB12)

The data generator memory can be extended to max. 79 Mbit by fitting up to two options R&S SMIQB12.

Memory capacity	32 Mbit
-----------------	---------

### Digital standards with options R&S SMIQB20 and R&S SMIQB11

Modulation and ACP specifications apply at the respective standard frequency ranges and at levels  
 $\leq 8$  dBm PEP with R&S SMIQ02B/03B  
 $\leq 5$  dBm PEP with R&S SMIQ04B/06B

<b>Data sources</b>	
with TDMA	internal, external via RS232 interface (SERDATA)
with CDMA	internal
<b>Digital standard GSM / EDGE</b>	<b>to GSM standard</b>
Frequency	
Standard	880 MHz to 960 MHz/1710 MHz to 2000 MHz
Range	same as R&S SMIQ
Modulation	GMSK or 8PSK EDGE (8PSK with $3\pi/8$ rotation)
Symbol rate	
Standard	270 833 Hz
Range	100 Hz to 300 kHz
Baseband filter (GMSK)	
Standard	Gauss, $B \times T = 0.3$
Range	Gauss, $B \times T = 0.2$ to $0.7$
Baseband filter (8PSK EDGE)	Gauss Linear
Frame structure	1 to 8 slots user-definable any burst types can be combined, incl. GSM and EDGE mixed
Burst types	NORMAL, DUMMY, ALL DATA, NORMAL EDGE
Burst on/off ratio	>80 dB
Burst rise/fall time	corresponding to 3 symbols, <18 $\mu$ s
Slot attenuation, selectable	0 dB to 70 dB
Internal modulation data	PRBS, $2^9-1$ , $2^{11}-1$ , $2^{15}-1$ , $2^{16}-1$ , $2^{20}-1$ , $2^{21}-1$ , $2^{23}-1$ , programmable data memory
External serial modulation data	asynchronous via RS232 interface (SERDATA)

<b>GMSK</b>	
Phase error, rms value	<1°, 0.3° typ.
Phase error, peak value	<3°, 1° typ.
<b>8PSK EDGE</b>	
Error vector magnitude, rms	<1.2%, 0.6% typ.
<b>Power density spectrum, typ. values (standard, resolution bandwidth 30 kHz, without power ramping)</b>	
Offset 200 kHz	-34 dB
Offset 400 kHz	-70 dB
Offset 600 kHz	-78 dB
<b>Digital standard DECT</b>	<b>to ETS300175-2 and ETS300176-1</b>
<b>Frequency</b>	
Standard	1880 MHz to 1900 MHz
Range	same as R&S SMIQ
<b>Modulation</b>	
Deviation with GFSK	GFSK (standard), $\pi/4$ DQPSK
Standard	288 kHz
Range	$(0.1 \text{ to } 1) \times f_{\text{symp}}$
<b>Symbol rate</b>	
Standard	1 152 000 Hz
Range with GFSK	100 Hz to 1 200 kHz
Range with $\pi/4$ DQPSK	100 Hz to 1 200 kHz
<b>Baseband filter</b>	
Standard	Gauss, $B \times T = 0.5$
Range	Gauss, $B \times T = 0.2 \text{ to } 0.7$ $\sqrt{\cos(\alpha = 0.2 \text{ to } 0.7)}, \cos(\alpha = 0.2 \text{ to } 0.7)$
<b>Frame structure</b>	
Slot types	1 to 12 slots of 24 slots user-definable FULL (basic), DOUBLE (high capacity), ALL DATA
Burst on/off ratio	>80 dB
Burst rise/fall time	corresponding to 2 symbols, <10 $\mu\text{s}$
Slot attenuation, selectable	0 dB to 70 dB
<b>Internal modulation data</b>	
	PRBS, $2^9-1$ , $2^{15}-1$ , $2^{16}-1$ , $2^{20}-1$ , $2^{21}-1$ , $2^{23}-1$ , programmable data memory
<b>Deviation error, rms</b>	
	<1.3%
<b>Special functions</b>	
Timing adjustment simulation	lengthening (+) or shortening (-) of every 35th frame
Range	-4 bit to +4 bit (resolution 1 bit)
Jitter simulation	time lead for even-numbered frames
Range	0 bit to +4 bit (resolution 1 bit)
Slot timing shift	time shifting of a single slot
Range	-9 bit to +9 bit (resolution 1 bit)
Selectable preamble	normal or prolonged
Response during ramp-up	modulated or CW
<b>Digital standard NADC</b>	<b>to IS-54 and IS-136</b>
<b>Frequency</b>	
Standard	824 MHz to 894 MHz/1850 MHz to 2000 MHz
Range	same as R&S SMIQ
<b>Modulation</b>	
	$\pi/4$ DQPSK
<b>Symbol rate</b>	
Standard	24.300 kHz
Range	100 Hz to 200 kHz

<b>Baseband filter</b>	
Standard	$\sqrt{\cos(\alpha=0.35)}, \cos(\alpha=0.35)$
Range	$\sqrt{\cos(\alpha=0.2 \text{ to } 0.7)}, \cos(\alpha=0.2 \text{ to } 0.7)$
Frame structure	1 to 6 slots user-definable for uplink and downlink
Burst types	Up/Down TCH, ALL DATA, Up SHORT
Burst on/off ratio	>80 dB
Burst rise/fall time	corresponding to 3 symbols, <123.4 $\mu$ s
Slot attenuation, selectable	0 dB to 70 dB
Internal modulation data	PRBS, 2 <sup>9</sup> -1, 2 <sup>11</sup> -1, 2 <sup>15</sup> -1, 2 <sup>16</sup> -1, 2 <sup>20</sup> -1, 2 <sup>21</sup> -1, 2 <sup>23</sup> -1, programmable data memory
External serial modulation data	asynchronous via RS232 interface (SERDATA)
Error vector magnitude, rms	<1.2%, 0.4% typ.
Adjacent-channel power, typ. values, without power ramping	
Offset 30 kHz	-35 dBc
Offset 60 kHz	-75 dBc
Offset 90 kHz	-78 dBc
<b>Digital standard PDC</b>	
Frequency	to RCR STD-27
Standard	810 MHz to 826 MHz/940 MHz to 956MHz /1429 MHz
Range	to 1453 MHz/1477 MHz to 1501 MHz
Modulation	same as R&S SMIQ
Modulation	$\pi/4$ DQPSK
<b>Symbol rate</b>	
Standard	21 kHz
Range	100 Hz to 200 kHz
<b>Baseband filter</b>	
Standard	$\sqrt{\cos(\alpha=0.5)}, \cos(\alpha=0.5)$
Range	$\sqrt{\cos(\alpha=0.2 \text{ to } 0.7)}, \cos(\alpha=0.2 \text{ to } 0.7)$
Frame structure	1 to 6 slots user-definable for uplink and downlink
Burst types	TCH, SYNC, VOX, ALL DATA
Burst on/off ratio	>80 dB
Burst rise/fall time	corresponding to 2 symbols, <95.2 $\mu$ s
Slot attenuation, selectable	0 dB to 70 dB
Internal modulation data	PRBS, 2 <sup>9</sup> -1, 2 <sup>11</sup> -1, 2 <sup>15</sup> -1, 2 <sup>16</sup> -1, 2 <sup>20</sup> -1, 2 <sup>21</sup> -1, 2 <sup>23</sup> -1, programmable data memory
External serial modulation data	asynchronous via RS232 interface (SERDATA)
Error vector magnitude, rms	<1.2%, 0.4% typ.
Adjacent-channel power, typ. values, without power ramping	
Offset 50 kHz	-74 dBc
Offset 100 kHz	-78 dBc
<b>Digital standard PHS</b>	
Frequency	to RCR STD-28
Standard	1895.0 MHz to 1918.1 MHz
Range	same as R&S SMIQ
Modulation	$\pi/4$ DQPSK
<b>Symbol rate</b>	
Standard	192 kHz
Range	100 Hz to 200 kHz
<b>Baseband filter</b>	
Standard	$\sqrt{\cos(\alpha=0.5)}, \cos(\alpha=0.5)$
Range	$\sqrt{\cos(\alpha=0.2 \text{ to } 0.7)}, \cos(\alpha=0.2 \text{ to } 0.7)$

Frame structure	1 to 8 slots user-definable
Burst types	TCH (32 kbit and 16 kbit channel), SYNC, VOX, ALL DATA
Burst on/off ratio	>80 dB
Burst rise/fall time	corresponding to 2 symbols, <13 $\mu$ s
Slot attenuation, selectable	0 dB to 70 dB
Internal modulation data	PRBS, $2^9-1$ , $2^{11}-1$ , $2^{15}-1$ , $2^{16}-1$ , $2^{20}-1$ , $2^{21}-1$ , $2^{23}-1$ , programmable data memory
External serial modulation data	asynchronous via RS232 interface (SERDATA)
Error vector magnitude, rms	<1.2%, 0.4% typ.
Adjacent-channel power, typ. values, without power ramping)	
Offset 600 kHz	-74 dBc
Offset 900 kHz	-76 dBc

### Digital standard IS-95 CDMA with option R&S SMIQB42

Modulation and ACP specifications apply at the respective standard frequency ranges and at levels  
 $\leq 8$  dBm PEP with R&S SMIQ02B/03B  
 $\leq 5$  dBm PEP with R&S SMIQ04B/06B

To TIA standard IS-95A and J-STD-008	
<b>Frequency</b>	
Standard	824 MHz to 894 MHz, 1850 MHz to 2000 MHz
Range	same as R&S SMIQ
Modulation	
QPSK, OQPSK	
<b>Chip rate</b>	
Standard	1.2288 MHz
Range	0.1 Mcps to 7 Mcps
Reverse link coded	0.1 Mcps to 1.3 Mcps
Sequence length	
Forward link	1 superframe (80 ms)
Reverse link	1 superframe (80 ms)
	if user-definable data lists are used:
Reverse link coded	calculation in real time, ie unlimited sequence length calculation in real time, ie unlimited sequence length
Baseband filter	
Standard	IS-95 with or without equalizer
Other filters	$\sqrt{\cos(\alpha=0.2 \text{ to } 0.7)}$ , $\cos(\alpha=0.2 \text{ to } 0.7)$
Forward link, mode 18	
Number of code channels	1 to 18
Walsh code selectable	0 to 63
Code channel power	0.0 dB to -30 dB, 4 user-definable levels
Forward link, mode 64	
Number of code channels	1 to 64
Code channel power	0.0 dB to -30 dB, 2 user-definable levels
Reverse link	
full-rate mode, half-rate mode with random power gating	
Reverse link coded	
incl. frame quality indicator, convolutional encoder, block interleaver	
traffic channel, 9600/4800/2400/1200 bps	
traffic channel, 14400/7200/3600/1800 bps	
access channel, 4800 bps	

Internal modulation data	
Forward link, 19200 bit/s	PRBS, 0 sequence, 1 sequence, 01 alternating, different for each code channel
Reverse link, 28800 bit/s	PRBS, 0 sequence, 1 sequence, 01 alternating, programmable data memory
Reverse link coded	PRBS, $2^9-1$ , $2^{15}-1$ , $2^{16}-1$ , $2^{20}-1$ , $2^{21}-1$ , $2^{23}-1$ , programmable data memory
Synchronization signals (chip rate 1.2288 Mcps)	chip clock, input and output, 2 outputs for 80 ms, 80/3 ms, 20 ms, 2 s clock, trigger input
Modulation accuracy $\rho$	>0.9996
Adjacent-channel power ratio at 30 kHz bandwidth	
Reverse link	
Offset 885 kHz	-77 dBc typ.
Offset 1.25 MHz	-83 dBc typ.
Offset 1.98 MHz	-84 dBc typ.
With option R&S SMIQB47, IQ filter 850 kHz	
Offset 885 kHz	<-78 dBc, -82 dBc typ.
Offset 1.25 MHz	<-83 dBc, -87 dBc typ.
Offset 1.98 MHz	<-85 dBc, -89 dBc typ.
9 channels forward link	
Offset 885 kHz	-77 dBc typ.
Offset 1.25 MHz	-79 dBc typ.
Offset 1.98 MHz	-80 dBc typ.
With option R&S SMIQB47, IQ filter 850 kHz	
Offset 885 kHz	<-74 dBc, -78 dBc typ.
Offset 1.25 MHz	<-80 dBc, -84 dBc typ.
Offset 1.98 MHz	<-83 dBc, -86 dBc typ.

### Digital standard WCDMA with option R&S SMIQB43

To NTT DoCoMo 1.0 and ARIB standard 0.0

Modulation and ACP specifications apply at the respective standard frequency ranges and at levels  
 $\leq 8$  dBm PEP with R&S SMIQ02B/03B  
 $\leq 5$  dBm PEP with R&S SMIQ04B/06B

<b>Frequency</b>	
Standard	1800 MHz to 2200 MHz
Range	same as R&S SMIQ
Modulation	QPSK, OQPSK
<b>General settings</b>	
Chip rate	
Standard	4.096 Mcps
Range	0.1 Mcps to 7 Mcps
Link direction	uplink and downlink
Sequence length	45 frames without option R&S SMIQB12 150 frames with 1 option R&S SMIQB12 240 frames with 2 options R&S SMIQB12
Baseband filter	
Standard	WCDMA 0.22
Other filters	$\sqrt{\cos(\alpha = 0.1 \text{ to } 0.7)}$ , $\cos(\alpha = 0.1 \text{ to } 0.7)$

<b>Code channels and spreading</b>	
Number	mode 4: 4 channels with different power mode 8: 8 channels, 1 channel with different power and 7 channels with equal power mode 15: 15 channels with equal power
Multicode operation	yes
Code channel power	0.0 dB to -30 dB
Short code	selectable for each code channel
Range	0 to 127
LMS	1 to FF hex
Long code	selectable for each code channel
Initial value uplink	0 to 1FFFFFFFFF hex
Initial value downlink	0 to 3FFFF hex
Time offset	0 to 40959 chips (1 radio frame)
<b>Physical channel with frame structure</b>	
Link direction	downlink, uplink, uplink IQ-multiplexed to ARIB 0.0
Downlink channels	perch 1, common control 64 ksps sample rate, dedicated channel with 32, 64, 128, 256, 512, 1024 ksps sample rate
Uplink channels	common control 64 ksps sample rate, dedicated channel with 32, 64, 128, 256, 512, 1024 ksps sample rate
Uplink channels (ARIB)	dedicated control channel with 16 ksps sample rate, dedicated data channel with 16, 32, 64, 128, 256, 512, 1024 ksps sample rate
Data offset	time offset, separately adjustable for each code channel
Range offset	0 to 1 radio frame
Resolution offset	1 symbol
<b>Internal modulation data</b>	
DATA field	PRBS, $2^9-1$ , $2^{11}-1$ , $2^{15}-1$ , $2^{16}-1$ programmable data memory
TPC field	00, 11, alternating, programmable data memory
Synchronization signals	chip clock, input and output outputs for slot, frame clock or marker for repetition of chip sequence trigger input
Error vector magnitude, rms	<2%, 1.5% typ.
with option R&S SMIQB47, IQ filter 2.5 MHz	<3%, 1.8% typ.
<b>Adjacent-channel power, 1 DTCH</b>	
Offset 5 MHz, low distortion output mode	-67 dBc typ. <sup>8)</sup>
Offset 10 MHz, low noise output mode	-70 dBc typ. <sup>8)</sup>
With option R&S SMIQB47, IQ filter 2.5 MHz	
Offset 5 MHz, low distortion output mode	<-65 dBc, -70 dBc typ. <sup>8)</sup>
Offset 10 MHz, low noise output mode	<-71 dBc, -74 dBc typ. <sup>8)</sup>

## Digital standard WCDMA 3GPP (FDD) with option R&S SMIQB45

To 3GPP standard 4.1.0 (FDD)

3GPP (FDD) version	4.1.0 to 3GPP technical specifications TS25.211, TS25.213, TS25.141, TS25.101 and TS25.104
<b>Frequency</b>	
Standard	1800 MHz to 2200 MHz
Range	same as R&S SMIQ
<b>General settings</b>	
Chip rate	
Standard	3.840 Mcps,
Range	1 Mcps to 5 Mcps

Link direction	uplink (reverse link) and downlink (forward link)
Sequence length	1 to 13 frames
Baseband filter	
Standard	$\sqrt{\cos}$ , $\alpha = 0.22$
Other filters	$\sqrt{\cos}$ , ( $\alpha = 0.1$ to $0.99$ ), $\cos$ ( $\alpha = 0.1$ to $0.99$ ), user filter
Clipping level	Setting of clipping value relative to highest peak in percent. Clipping takes place prior to baseband filtering and reduces the crest factor. The range is 1 to 100 %.
Code channels	
Downlink	up to 512 data channels (plus special channels) divided among up to four base stations (BS) with 128 code channels each
Uplink	up to four mobile stations (MS) each operating in one of modes PRACH only, PCPCH only, DPCCH + DPDCHs
<b>Physical channels in downlink</b>	
P-CPICH	Primary Common Pilot Channel
Symbol rate	15 ksps, fixed
Channelization code	0, fixed
Slot structure	predefined symbols
S-CPICH	Secondary Common Pilot Channel
Symbol rate	15 ksps, fixed
Channelization code	0 to 255
Slot structure	predefined symbols
P-SCH	Primary Sync Channel
Symbol rate	15 ksps, fixed
Slot structure	synchronization code (SC)
S-SCH	Secondary Sync Channel
Symbol rate	15 ksps, fixed
Slot structure	synchronization code (SC)
P-CCPCH	Primary Common Control Physical Channel
Symbol rate	15 ksps, fixed
Channelization code	1, fixed
Slot structure	data
S-CCPCH	Secondary Common Control Physical Channel
Symbol rate	15, 30, 60, 120, 240, 480, 960 ksps
Channelization code	depending on symbol rate, 0 to max. 255
Slot structure	data, TFCI, pilot
PICH	Page Indication Channel
Symbol rate	15 ksps, fixed
Channelization code	0 to 255
Number of PIs per frame	18, 36, 72, 144
Slot structure	page indicator bits, not used bits
AP-AICH	Access Preamble Acquisition Indication Channel
Symbol rate	15 ksps, fixed
Channelization code	0 to 255
Slot structure	acquisition indicators, empty symbols

AICH	Acquisition Indication Channel
Symbol rate	15 ksps, fixed
Channelization code	0 to 255
Slot structure	acquisition indicators, empty symbols
PDSCH	Physical Downlink Shared Channel
Symbol rate	15, 30, 60, 120, 240, 480, 960 ksps
Channelization code	depending on symbol rate, 0 to max. 255
Slot structure	data
DL-DPCCH	Dedicated Physical Control Channel
Symbol rate	7.5 ksps, fixed
Channelization code	0 to 511
Slot structure	TPC, pilot
DPCH	Dedicated Physical Channel
Symbol rate	7.5, 15, 30, 60, 120, 240, 480, 960 ksps
Channelization code	depending on symbol rate, 0 to max. 511
Slot structure	data 1, TPC, TFCl, data 2, pilot
<b>Physical channels in uplink</b>	
PRACH	Physical Random Access Channel
Symbol rate	15, 30, 60, 120 ksps
Frame structure	preamble(s), message part consisting of data and control section
Preamble part power	-60 dB to 0 dB
Data part power	-60 dB to 0 dB
Control part power	-60 dB to 0 dB
Preamble repetition	1 to 10
Signature	0 to 15
Access slot	0 to 14
Message part length	1 or 2 frames
TFCl	0 to 1023
User data	PRBS: PN9, PN11, PN15, PN16 all 0, all 1 and bit pattern (max. 24 bit long)
PCPCH	Physical Common Packet Channel
Symbol rate	15, 30, 60, 120, 240, 480, 960 ksps
Frame structure	access preamble(s), collision detection preamble, power control preamble, message part consisting of data and control section
Preamble part power	-60 dB to 0 dB
Data part power	-60 dB to 0 dB
Control part power	-60 dB to 0 dB
Preamble power step	0 dB to 10 dB
Preamble repetition	1 to 10
Signature	0 to 15
Access slot	0 to 14
Message part length	1 to 10 frames
Power control preamble length	0 or 8 slots
FBI state	OFF/1 bit/2 bit
FBI pattern	all 0, all 1 and bit pattern (max. 24 bit long)
User data	PRBS: PN9, PN11, PN15, PN16 all 0, all 1 and bit pattern (max. 24 bit long)
DPCCH	Dedicated Physical Control Channel
Symbol rate	15 ksps, fixed
Channelization code	0, fixed
DL-UL timing offset	1024 chips, fixed
Slot format	0 to 5
FBI state	OFF/1 bit/2 bit
FBI pattern	all 0, all 1 and bit pattern (max. 24 bit long)
TFCl state	OFF/ON
TFCl	0 to 1023
Use TPC for dynamic output	OFF/ON
Power control	if this function is active, the TPC pattern is used to vary the transmit power of the MS code channels versus time
Output power control step	-10 dB to +10 dB



DPDCH	Dedicated Physical Data Channel
Overall symbol rate	overall data rate of all uplink DPDCHs 15, 30, 60, 120, 240, 480, 960, 2 x 960, 3 x 960, 4 x 960, 5 x 960, 6 x 960 ksp/s
Active DPDCHs	1 to 6, depending on overall symbol rate
Symbol rate	fixed for active DPDCHs, depending on overall symbol rate
Channelization code	fixed for active DPDCHs, depending on overall symbol rate
Channel power	-60 dB to 0 dB for all DPDCHs
User data	PRBS: PN9, PN11, PN15, PN16 all 0, all 1 and bit pattern (max. 24 bit long)
<b>Parameters for each base station (BS)</b>	
State	OFF/ON
2nd search code group	0 to 63 (depending on scrambling code)
Scrambling code	0 to 5FFFF hex or off
TFCI state	OFF/ON
TFCI	0 to 1023
TPC pattern readout mode	use of TPC pattern: continuous, single + all 0, single + all 1, single + alternating 01, single + alternating 10
Use TPC for dynamic output power control	OFF/ON if this function is active, the TPC pattern is used to vary the transmit power of the code channels versus time
Output power control step	-10 dB to +10 dB
Transmit diversity	OFF/antenna 1/antenna 2 if this function is active, the output signal for antenna 1 or antenna 2 can be generated as defined in the standard
<b>Parameter for each mobile station (MS)</b>	
State	OFF/ON
Mode	PRACH only, PCPCH only, DPCCH + DPDCHs
Scrambling code	0 to FF FFFF hex
Scrambling code mode	long, short, off
TPC pattern	all 0, all 1 and bit pattern (max. 24 bit long)
TPC pattern readout mode	use of TPC pattern: continuous, single + all 0, single + all 1, single + alternating 01, single + alternating 10
<b>Parameters for each downlink code channel, independently selectable</b>	
State	OFF/ON
Symbol rate	between 7.5 ksp/s and 960 ksp/s, depending on type of physical channel
Channelization code	range 0 to max. 511, depending on symbol rate and type of physical channel
Power	-60 dB to 0 dB
User data	PRBS: PN9, PN11, PN15, PN16 all 0, all 1 and bit pattern (max. 24 bit long)
Timing offset	separately adjustable for each code channel 0 to 150 (in units of 256 chips)
Pilot length	2, 4, 8, 16 bit depending on symbol rate
TPC pattern	all 0, all 1 and bit pattern (max. 24 bit long)
Multicode state	OFF/ON

## Assistant functions to facilitate operation

Test models	
Downlink	test model 1 with 16/32/64 channels test model 2 test model 3 with 16/32 channels test model 4
Uplink (not standardized)	DPCCH + 1 DPDCH at 60 ksps sample rate DPCCH + 1 DPDCH at 960 ksps sample rate
Parameterizable predefined settings	generation of complex signal scenarios in downlink with parameterizable default settings selectable parameters: use and symbol rate of special channels (for synchronization of mobile), number and symbol rate of data channels, crest factor: minimal/average/worst
Multichannel edit	common configuration of data channels of BS channel table; selectable parameters, partly with start value and step size: range of data channels to be set, symbol rate, channelization code with step size, channel power with step size, data, TPC, timing offset with step size, multicode state, state
Copy BS/MS	adopting the configuration of a BS for another BS/MS for the definition of multi-BS/MS scenarios or BS signals with more than 128 channels parameters: source and destination of copying, channelization code offset for simple definition of BS signals with more than 128 channels and continuous channelization codes
Resolve domain conflicts	elimination of code channel overlapping in code domain (domain conflicts) occurring in a BS/MS

## Graphic displays

Domain conflicts	Display of domain conflicts (overlapping of code channels in code domain) in the lines concerned of the channel tables. The code domain occupied by the code channels involved in the conflict can also be displayed.
Code domain	Display of code domain occupied by current BS. Domain areas in which conflicts occur are highlighted. The distribution of code channels in the code domain as well as channel powers are shown qualitatively.
Channel graph	Display of all active channels of a BS versus the channel table index. The powers of the code channels are shown qualitatively.
CCDF	Display of complementary cumulative distribution function of current signal. This function gives the probability of the magnitudes of complex IQ samples exceeding a predefined threshold. Together with the current CCDF, the CCDFs of the two 3GPP signals last generated can be displayed to observe the effect of parameter changes. The crest factor of the signal can be seen in the CCDF.
Constellation diagram	Display of constellation diagram versus IQ samples of current 3GPP signal. This diagram allows qualitative assessment of channel configuration, channel power ratios, and the effect of parameters such as data and data offset.

**Adjacent-channel power, 1 DPCH (crest factor=5,4 dB)**

Chip rate 3.84 MHz

**Without option R&S SMIQB47**

Offset 5 MHz, low distortion output mode	-67 dBc typ. <sup>8)</sup>
Offset 10 MHz, low noise output mode	-70 dBc typ. <sup>8)</sup>

**With option R&S SMIQB47, IQ filter 2.5 MHz**

Offset 5 MHz, low distortion output mode	<-65 dBc, -70 dBc typ. <sup>8)</sup>
Offset 10 MHz, low noise output mode	<-71 dBc, -74 dBc typ. <sup>8)</sup>

**Adjacent-channel power, test model 1, 64 DPCH (crest factor= 10,6 dB)****Without option R&S SMIQB47**

Offset 5 MHz, low distortion output mode	-64 dBc typ. <sup>8)</sup>
Offset 10 MHz, low noise output mode	-67 dBc typ. <sup>8)</sup>

**With option R&S SMIQB47, IQ filter 2.5 MHz**

Offset 5 MHz, low distortion output mode	<-64 dBc, -68 dBc typ. <sup>8)</sup>
Offset 10 MHz, low noise output mode	<-67 dBc, -70 dBc typ. <sup>8)</sup>

**Enhanced functions for digital standard WCDMA 3GPP (FDD) with option R&S SMIQB48**

3GPP (FDD) version 4.1.0 to 3GPP technical specifications TS25.101, TS25.104, TS25.141, TS25.211 and TS25.213

**Option R&S SMIQB45 WCDMA 3GPP is extended by the following functions:****Enhanced Channels**

Channels of WCDMA system in R&S SMIQ that offer enhanced functionality compared with standard channels of option R&S SMIQB45.

Can be used in downlink for max. four DPCHs and in uplink for one DPCCH and max. six DPDCHs.

All DPCHs or DPDCHs have the same symbol rate.

Enhanced functions at a glance:

- Sequences of up to 1022 frames
- Realtime BCH with incrementing SFN
- Data lists for data fields and TPC field
- External power control
- Channel coding
- Bit error insertion
- Block error insertion
- Orthogonal channel noise simulation (OCNS)
- Additional mobile stations

**Sequences of up to 1022 frames**

generation of WCDMA signals with length of max. 256 frames with four active enhanced channels and max. 1022 frames with one active enhanced channel

**Applications**

- continuous measurement of physical bit error rate (without channel coding) on code channel with PN9 data without wrap-around problems
- use of user data (data lists) with externally processed long data sequences for enhanced channels

**Realtime BCH with incrementing SFN**

Generation of a realtime downlink BCH (coded P-CCPCH) with incrementing system frame number (0 to 4094). BCH can be combined with all reference measurement channels (bit rate 12.2 kbps, 64 kbps, 144 kbps, 384 kbps) or AMR of 12.2 kbps bit rate.

Max. sequence length:

RMC	12.2 kbps	2044 frames
RMC	64 kbps	512 frames
RMC	144 kbps	512 frames
RMC	384 kbps	512 frames
AMR	12.2 kbps	2044 frames

**Application**

- receiver and performance tests to TS25.101
- test of mobile synchronization to BS signal combined with: continuous measurement of DTCH and DCCH bit and block error rate using PN9 data

<b>Data lists for data fields and TPC field</b>	For the enhanced channels, the data fields and the transmit power control (TPC) field of the slots can be filled from data lists. This allows the use of externally precoded data or the generation of long power control profiles for the DUT.
Applications	<ul style="list-style-type: none"> <li>– measurement of UE power control steps</li> <li>– measurement of UE max. output power</li> </ul>
<b>External power control</b>	Variation of output power of max. 4 enhanced channels in realtime via external control line. The power of all active enhanced channels can be increased or decreased jointly by means of a TTL signal.
Common parameters	
Power step	0.25 dB to 30 dB
Power up range	0 dB to 30 dB
Power down range	0 dB to 30 dB
Parameters for each enhanced channel	
Start power	–60 dB to 0 dB
Power control	OFF; UP; DOWN
Graphic display	current output power (differential power relative to start power) of channels with external power control shown by bargraph
Application	test of SIR based closed loop power control
<b>Channel coding</b>	Coding of up to four enhanced channels in accordance with definition of reference measurement channels given in TS25.101, TS25.104 and TS25.141. In addition, AMR speech 12.2 kbps to TS25.944 and RACH/CPCH (TB size 168 bit or 360 bit, data PN9 fixed) to TS25.141 are supported. Common coding scheme and symbol rate for all enhanced channels.
Implemented reference measurement channels	<ul style="list-style-type: none"> <li>– uplink reference measurement channel for 12.2 kbps, 64 kbps, 144 kbps, 384 kbps</li> <li>– downlink reference measurement channel for 12.2 kbps, 64 kbps, 144 kbps, 384 kbps</li> </ul>
Channel coding structure	<ul style="list-style-type: none"> <li>– CRC attachment</li> <li>– tail bit attachment</li> <li>– convolutional coding or turbo coding, depending on symbol rate</li> <li>– 1st interleaving</li> <li>– radio frame segmentation</li> <li>– rate matching</li> <li>– 2nd interleaving</li> </ul>
Sequence length of coded signal	
4 enhanced channels	up to 256 frames (10 ms each)
1 enhanced channel	up to 1022 frames (10 ms each)
Applications	<p>bit error rate (BER) measurements to TS25.101/104 (radio transmission and reception), eg:</p> <ul style="list-style-type: none"> <li>– blocking characteristics</li> <li>– spurious response</li> <li>– intermodulation characteristics</li> </ul> <p>block error rate (BLER) measurements to TS25.101/104 (radio transmission and reception), eg:</p> <ul style="list-style-type: none"> <li>– demodulation of dedicated channel under static propagation conditions (in conjunction with R&amp;S SMIQB17)</li> <li>– demodulation of dedicated channel under multipath fading propagation conditions (in conjunction with R&amp;S SMIQB14 and -B17)</li> <li>– test of receiver decoder</li> </ul>

<b>Bit error insertion</b>	generation of bit errors by impairment of data stream, either before coding in case of active channel coding, or otherwise at the physical layer
Parameter Bit error rate (nominal BER)	$10^{-1}$ to $10^{-7}$ with display of resulting BER
Application	verification of internal BER calculation to TS25.141 (BS conformance testing)
<b>Block error insertion</b>	generation of block errors by impairment of CRC during coding of enhanced channels
Parameter Block error rate (nominal BLER)	$10^{-1}$ to $10^{-4}$ with display of resulting BLER
Application	verification of internal BLER calculation to TS25.141 (BS conformance testing)
<b>Orthogonal channel noise simulation (OCNS)</b>	Simulation of orthogonal background or interference channels for enhanced channels of a base station. If this feature is activated, 16 DPCHs according to TS25.241, 4.1.0, table C.6 are added. The total power of the OCNS part is adjusted automatically in order to achieve a total power of 0 dB.
Applications	<ul style="list-style-type: none"> <li>– test of mobile receiver under realistic conditions</li> <li>– measurement of maximum input level to TS25.101</li> </ul>
<b>Additional mobile stations</b>	Simulation of up to 64 mobile stations in addition to the four user-configurable mobile stations of option R&S SMIQB45. The scrambling codes of the additional mobiles differ from one another.
Parameters	
Number of additional MS	1 to 64
Scrambling code step	1 to 1000 hex
Power offset	-20 to 20 dB
Applications	base station test under realistic receiving conditions
<b>Requirements for installation of option R&amp;S SMIQB48</b>	R&S SMIQxxB with options R&S SMIQB20, R&S SMIQB45, R&S SMIQB11. Maximum sequence length of enhanced channels requires maximum memory extension of data generator, ie two options R&S SMIQB12.

### Arbitrary waveform generator with option R&S SMIQB60

<b>Waveform memory, interpolation</b>	
Output memory Length of waveform	1 to 524216 in steps of one sample
<b>Note:</b> The specified waveform length cannot be directly compared with the relevant data of conventional ARB generators. In R&S SMIQB60, the oversampling needed for suppressing repetitive spectra by means of the analog filter is effected automatically and in realtime by way of <u>hardware</u> interpolation, ie the stored waveform is not extended by the oversampling factor. For W-CDMA signals, for example, oversampling of only 1.62 is needed. This compares with a conventional ARB with oversampling of 4, meaning that R&S SMIQB60 output memory capacity corresponds to 1.25 Msamples.	
Resolution	12 bit
Loading time for 512k I/Q samples	4 s
Nonvolatile memory	
Number of blocks	22 (one waveform occupies at least one block)
Block size	65527
Interpolation	
Interpolation bandwidth (-0.1 dB)	0.375 x clock rate
Repetitive spectra suppression through analog filter	>70 dB

<b>Clock generation</b>	
Clock rate	1 kHz to 40 MHz
Resolution	0.001 Hz
Clock mode	internal or external
Error	$<2^{-42}$ related to reference frequency
<b>Signal output</b>	
Channels	2 (I and Q)
Output impedance	50 $\Omega$
Output level (EMF, peak)	
Normal mode	$\sqrt{I^2 + Q^2} = 1\text{ V}$
Manual mode	-6 dB to 0 dB referred to 1 V, setting range up to +3 dB
Level difference between channels	$<0.2\%$ at 1 kHz <sup>3)</sup>
DC offset	$<-54$ dB in normal mode <sup>3)</sup>
Frequency response	
Magnitude	
up to 12 MHz	$<1$ dB
up to 10 MHz	0.1 dB typ.
Group delay	
up to 10 MHz	1 ns typ.
I/Q imbalance	
Magnitude	
up to 10 MHz	0.05 dB typ.
Group delay	
up to 10 MHz	0.5 ns typ.
SFDR (sinewave 1 MHz, clock 4 MHz, measurement range up to 12 MHz)	$>60$ dB
<b>Trigger</b>	
Trigger modes	auto, retrig, armed auto, armed retrig
Trigger source	internal or external
External trigger input	threshold -2.5 V to 2.5 V, impedance 1 k $\Omega$ / 50 $\Omega$
External trigger frequency	$<10$ MHz
External trigger delay range	0 to $2^{16}$ samples
External trigger inhibit range	0 to $2^{26}$ samples
Pulse width	$>50$ ns
<b>Trigger outputs</b>	
Number	2
Delay	0 to 524216 samples
On time	1 to 524215 samples
Off time	1 to 524215 samples
Level	TTL
<b>Graphic displays</b>	
CCDF	determination and graphic display of CCDF of waveform loaded into output memory; CCDF also serves for crest factor determination. The CCDF traces of the three waveforms last loaded can be displayed simultaneously.
<b>Operation with WinIQSIM™</b>	
WinIQSIM™ is a Windows software that allows a wide variety of I and Q baseband signals to be calculated on a PC (see WinIQSIM™ data sheet PD 0757.6940). From version 3.30, the software supports downloading of waveforms into R&S SMIQ and operation of option R&S SMIQB60 from a PC.	

## Software options R&S SMIQK11 to -K18

For specifications of digital standards with R&S WinIQSIM™ and R&S SMIQB60, R&S SMIQK11 to -K18 please refer to the WinIQSIM™ data sheet PD 0757.6940

## Simultaneous modulation

Any combination is possible with the following exceptions:  
 Simultaneous FM and  $\phi$ M  
 Simultaneous digital modulation and vector modulation

## Overview of digital TDMA standards

The table below summarizes the key data for the digital TDMA standards implemented in R&S SMIQ. Options R&S SMIQB20 and R&S SMIQB11 are required for all standards.

	GSM (GMSK)	GSM-EDGE (8PSK)	DECT	NADC	PDC	PHS
Error vector magnitude, rms	N/A	<1.2 %, 0.6 % typ.	N/A	<1.2 %, 0.4 % typ.	<1.2 %, 0.4 % typ.	<1.2 %, 0.4 % typ.
Phase error (standard), rms	<1°, 0.3° typ.	N/A	N/A	N/A	N/A	N/A
Peak value	<3°, 1° typ.					
Deviation error, rms	N/A	N/A	<1.3 %	N/A	N/A	N/A
Channel spacing/kHz	200	200	1728	30	25	300
Power density spectrum, typ. resolution BW 30 kHz						
Offset 200 kHz	-34 dB	-34 dB	N/A	N/A	N/A	N/A
400 kHz	-70 dB	-70 dB				
600 kHz	-78 dB	-78 dB				
Adjacent-channel power ratio (ACPR), typ.						
at adjacent channel				-35 dBc	-	-
at 1st alternate channel	N/A	N/A	N/A	-75 dBc	-74 dBc	-74 dBc
at 2nd alternate channel				-78 dBc	-	-76 dBc
at 3rd alternate channel				-	-78 dBc	-
Burst types	NORMAL, DUMMY, ALL DATA	NORMAL EDGE	FULL (basic), DOUBLE (high capacity), ALL DATA	Up/Down TCH, ALL DATA, Up SHORT	TCH, SYNC, VOX, ALL DATA	TCH (32 kbit and 16 kbit), SYNC, VOX, ALL DATA

## Options for special applications

### Fading simulation with options R&S SMIQB14, R&S SMIQB15<sup>13)</sup>

RF bandwidth (–3 dB)	>14 MHz
<b>Additional frequency response</b>	
up to 5 MHz offset from carrier	<0.6 dB, <0.4 dB typ.
Carrier leakage	–45 dBc typ.
Setting time after RF frequency change	<3 ms
Modes	external via I and Q modulation inputs, internal with option R&S SMIQB20
<b>Number of paths and channels</b>	
with option R&S SMIQB14	6 paths, 1 channel
with options R&S SMIQB14 and -B15	12 paths, 1 channel, or 6 + 6 paths, 2 channels with second R&S SMIQ through simple retrofit (for instructions see manual)
<b>Path attenuation</b>	
Range	0 dB to 50 dB
Resolution	0.1 dB
Error (in range 0 dB to 20 dB)	<0.3 dB
<b>Path delay</b>	
Range	0 µs to 1600 µs
Resolution	50 ns
Error	<5 ns
<b>Doppler shift</b>	
Frequency range	0.1 Hz to 1600 Hz
Speed range	$v_{\min} = \frac{0,03 \times 10^9 \frac{\text{m}}{\text{s}^2}}{f_{\text{RF}}} \quad v_{\max} = \frac{479 \times 10^9 \frac{\text{m}}{\text{s}^2}}{f_{\text{RF}}}$
Example with $f_{\text{RF}} = 1 \text{ GHz}$ : $v_{\min} = 0.1 \text{ km/h}$ , $v_{\max} = 1724 \text{ km/h}$	
Resolution	0.1 km/h, m/s, mph
Error	<0.13%
<b>Rayleigh fading</b>	
Pseudo noise interval	>372 h
Deviation from theoretical CPDF <sup>4)</sup> for $P_{\text{avg}} = 0 \text{ dB}$	
Path attenuation from –20 dB to +10 dB	<1 dB, <0.3 dB typ.
Path attenuation from –30 dB to –20 dB	<2 dB, <0.3 dB typ.
<b>Rice fading</b>	
Power ratio <sup>5)</sup>	
Range	–30 dB to +30 dB
Resolution	0.1 dB
Frequency ratio	
Range	–1 to +1
Resolution	0.05
<b>Lognormal fading, Suzuki fading</b>	
Standard deviation	
Range	0 dB to 12 dB
Resolution	1 dB
Local constant	$l_{\min} \text{ to } 200 \text{ m}$ $l_{\min} = \frac{12 \times 10^9 \frac{\text{m}}{\text{s}}}{f_{\text{RF}}}$
<b>Correlation</b>	paths 1 to 6 with paths 7 to 12
Magnitude range	0% to 100%
Resolution	5%
Phase range	0° to 360°
Resolution	1°
General data; thermal loading	specs valid in range 0 °C to 45°C



## Enhanced fading functions for WCDMA 3GPP with option R&S SMIQB49

The following data deviate from the specifications for R&S SMIQB14/R&S SMIQB15:

Modes	standard fading, fine delay, moving delay, birth-death
Setting time after RF frequency change	6 ms
<b>Fine delay mode</b>	
RF bandwidth	4.8 MHz
Number of paths	2 (with R&S SMIQB14), 4 (with R&S SMIQB14 + R&S SMIQB15)
Profiles	Rayleigh, pure Doppler
Delay	25 ns to 1637 $\mu$ s
Delay resolution	1 ns
<b>Moving delay mode</b>	
RF bandwidth	4.8 MHz
Number of paths	2
Delay, path 1	0 to 1000 $\mu$ s (in 50 ns steps)
Delay, path 2	$\text{delay path 1} + \frac{\text{delay variation}_{\text{pk-pk}}}{2} \times \sin \frac{2\pi t}{\text{variation period}}$
Delay variation (peak-peak)	150 ns to 50 $\mu$ s
Variation period	10 s to 500 s
Delay step size	<1 ns
Profiles	none
<b>Birth-death mode</b>	
Number of paths	2
Profiles	pure Doppler
Delay	5 $\mu$ s to 1000 $\mu$ s
Delay range (birth-death process)	5 $\mu$ s to +5 $\mu$ s (not variable)
Delay grid	1 $\mu$ s (not variable)
Hopping dwell	100 ms to 5 s

## Noise and distortion simulation with option R&S SMIQB17<sup>13)</sup>

RF bandwidth (-3 dB)	>14 MHz
Additional frequency response up to 5 MHz offset from carrier	<0.6 dB, 0.4 dB typ.
Carrier leakage <sup>9)</sup>	-40 dBc typ.
<b>Distortion simulator</b>	
Type of distortion	AM/AM and AM/ $\phi$ M distortion of modulation signal
Distortion characteristic	each characteristic programmable by entering up to 30 input values via IEC/IEEE bus or by entering up to five polynomial coefficients
Resolution	12 bit
<b>Noise generator (AWGN)</b>	
Distribution density	Gaussian, statistically independent for I and Q
Crest factor	14 dB
<b>C/N</b>	
Range	-30 dB to 30 dB
Resolution	0.1 dB
Error for system bandwidth = symbol rate and C/N <20 dB <sup>3)</sup>	
Vector, PSK, QAM modulation	<0.4 dB
FSK, GMSK modulation <sup>10)</sup>	<0.4 dB
System bandwidth	relevant bandwidth for determining noise power N
Range	10 kHz to 10 MHz
Resolution	$1 \times 10^{-2}$
Output spectrum	white noise
Frequency response up to 0.7 x system bandwidth and 5 MHz offset from carrier at RF output <sup>3)</sup>	<0.8 dB

## Bit error rate measurement with option R&S SMIQB21

The data supplied by the DUT are compared with a reference pseudo-random bit sequence.	
Pseudo-random bit sequences (PRBS)	$2^9-1, 2^{11}-1, 2^{15}-1, 2^{16}-1, 2^{20}-1, 2^{21}-1, 2^{23}-1$
Clock source	supplied by DUT; a clock pulse is required for each valid bit
Clock rate	100 Hz to 30 MHz
Synchronization time	24 clock cycles
Interface	9-pin sub-D connector, sub-D/BNC cable supplied with option
Data	TTL
Data enable	TTL
Clock	TTL
Restart	TTL
Setup time	10 ns
Hold time	2 ns
Polarity	normal and inverted (data, clock, data enable)
Measurement time	selectable through maximum number of data bits or bit errors (max. $2^{31}$ bit each), continuous measurement
Measurement result	BER in ppm, % or decade values (if selected number of data bits or bit errors is attained) status displays: not synchronized, no clock, no data

## Option R&S SMIQB47 for improved adjacent-channel power ratio for WCDMA and CDMA IS-95

Modulation and ACP specifications apply at the respective standard frequency ranges and at levels  
 $\leq 8$  dBm PEP with R&S SMIQ02B/03B  
 $\leq 5$  dBm PEP with R&S SMIQ04B/06B

Selectable baseband filters to improve ACP values (values see at Digital Standards CDMA/WCDMA)	
Bandwidth	OFF, 850 kHz, 2.5 MHz, 5 MHz
<b>WCDMA</b> chiprate 3.84 Mcps /4.096 Mcps, 1DPCH/1DTCH, $f = 1800$ MHz to 2200 MHz, IQ filter 2.5 MHz	
Offset 5 MHz, low distortion output mode	$< -65$ dBc, $-70$ dBc typ. <sup>8)</sup>
Offset 10 MHz, low noise output mode	$< -71$ dBc, $-74$ dBc typ. <sup>8)</sup>
<b>IS-95 CDMA</b> , $f = 824$ MHz to 894 MHz and 1850 MHz to 2000 MHz, IQ filter 850 kHz	
Reverse link	
Offset 885 kHz	$< -78$ dBc, $-82$ dBc typ.
Offset 1.25 MHz	$< -83$ dBc, $-87$ dBc typ.
Offset 1.98 MHz	$< -85$ dBc, $-89$ dBc typ.
9 channels forward link	
Offset 885 kHz	$< -74$ dBc, $-78$ dBc typ.
Offset 1.25 MHz	$< -80$ dBc, $-84$ dBc typ.
Offset 1.98 MHz	$< -83$ dBc, $-86$ dBc typ.
<b>Error vector magnitude, rms</b>	
<b>WCDMA</b> chiprate 3.84 Mcps /4.096 Mcps, IQ filter 2.5 MHz	
	$< 3\%$ , 1.8% typ.
<b>IS-95 CDMA</b> IQ filter 850 kHz	
	$< 2\%$ , 1.3% typ.

## Other data

### Memory for instrument settings

50 storable settings

Memory sequence modes	automatic, single shot, manual or external trigger
Step time	50 ms to 60 s
Resolution	1 ms

### List mode

Frequency and level values can be stored in a list and set in an extremely short time; permissible level variation: 90 dB	
Modes	automatic, single shot, manual or external trigger
Max. number of channels	2000
Dwell time	0.5 ms to 1 s
Resolution	0.1 ms

### Remote control

System	IEC 60625 (IEEE 488)
Command set	SCPI 1993.0
Connector	24-contact Amphenol
IEC/IEEE-bus address	0 to 30
Interface functions	SH1, AH1, T6, L4, SR1, RL1, PP1, DC1, DT1, C0
System	RS 232
Command set	SCPI 1993.0
Connector	9-contact D-SUB
Baud rate	1.2 kbit/s to 115.2 kbit/s

### General data

Power supply	100 V to 240 V (AC) $\pm$ 10%, 50 Hz to 400 Hz, autosetting to AC supply, max. 300 VA
<b>Electromagnetic compatibility</b>	to EN 55011 and EN 61326-2 (EMC directive of EU)
RF leakage at carrier frequency <1 GHz	<0.1 $\mu$ V (induced in a two-turn coil 25 mm dia. at a distance of 25 mm from any surface of the enclosure)
Immunity to RFI	10 V/m
<b>Ambient conditions</b>	
Operating temperature range	0°C to 50°C <sup>6)</sup> to IEC60068
Storage temperature range	-40°C to +70°C
Climatic conditions	95% relative humidity at +25°C/+40°C cyclically, to IEC 60068
<b>Mechanical resistance</b>	
Sinewave vibrations	5 Hz to 150 Hz, max. 2 g at 55 Hz, max. 0.5 g in range 55 Hz to 150 Hz, to IEC 60068, IEC 61010 and MIL-T-28800D, class 5
Random	10 Hz to 300 Hz, acceleration 1.2 g (rms)
Shock	40 g shock spectrum, to MIL-STD-810D, MIL-T-28800D, class 3 and 5
Safety	to EN 61010-1
Dimensions (W x H x D)	435 mm x 192 mm x 460 mm
Weight	25 kg when fully equipped

## Ordering information

<b>Vector Signal Generator</b>	R&S SMIQ02B 300 kHz to 2.2 GHz		1125.5555.02
	R&S SMIQ03B 300 kHz to 3.3 GHz		1125.5555.03
	R&S SMIQ04B 300 kHz to 4.4 GHz		1125.5555.04
	R&S SMIQ06B 300 kHz to 6.4 GHz		1125.5555.06
<b>Accessories supplied</b>	power cable, operating manual		
<b>Options</b>			
Reference Oscillator OCXO	R&S SM-B1		1036.7599.02
FM/φM Modulator	R&S SM-B5 <sup>13)</sup>		1036.8489.02
Data Generator	R&S SMIQB11		1085.4502.04
Memory Extension, 32 Mbit	R&S SMIQB12		1085.2800.04
Fading Simulator, 6 paths	R&S SMIQB14 <sup>13)</sup>		1085.4002.02
Second Fading Simulator for 12 paths or 2 channels	R&S SMIQB15 <sup>13)</sup>		1085.4402.02
Noise Generator and Distortion Simulator	R&S SMIQB17 <sup>13)</sup>		1104.9000.02
RF and AF Rear Connectors	R&S SMIQB19		1085.2997.02
Modulation Coder	R&S SMIQB20		1125.5190.02
BER Measurement	R&S SMIQB21		1125.5490.02
Digital Standard IS-95 CDMA	R&S SMIQB42		1104.7936.02
Digital Standard WCDMA to NTT DoCoMo 1.0, ARIB 0.0 standard	R&S SMIQB43		1104.8032.02
Digital Standard WCDMA to 3GPP (FDD)	R&S SMIQB45		1104.8232.02
Low ACP for IS-95 CDMA and W-CDMA	R&S SMIQB47		1125.5090.02
Extended Functions for WCDMA (3GPP)	R&S SMIQB48		1105.0587.02
Extended Fading Functions for WCDMA (3GPP)	R&S SMIQB49		1105.1083.02
Arbitrary Waveform Generator incl. R&S WinQSIM™	R&S SMIQB60		1136.4390.02
TETRA T1 Simulator	R&S SMIQ-K8		1136.4290.02
Digital Standard IS-95 CDMA (for option R&S SMIQB60)	R&S SMIQK11		1105.0287.02
Digital Standard cdma2000 (for option R&S SMIQB60)	R&S SMIQK12		1105.0435.02
Digital Standard WCDMA TDD Mode (3GPP) (for option R&S SMIQB60)	R&S SMIQK13		1105.1231.02
Digital Standard TD-SCDMA (for option R&S SMIQB60)	R&S SMIQK14		1105.1383.02
OFDM Signal Generation, HIPERLAN/2 (for option R&S SMIQB60)	R&S SMIQK15		1105.1531.02
Digital Standard IEEE 802.11b (for option R&S SMIQB60)	R&S SMIQK16		1154.7700.02
Digital Standard 1xEV-DO (for option R&S SMIQB60)	R&S SMIQK17		1154.7800.02
Digital Standard IEEE 802.11a (for option R&S SMIQB60)	R&S SMIQK18		1154.7952.02
Hint: R&S SMIQ02B/03B (R&S SMIQ04B/06B) can be equipped with max. three (two) of the following options: R&S SM-B5, R&S SMIQB14, R&S SMIQB15, R&S SMIQB17			
<b>Application software</b>			
PC Software: Generation of data and control lists	R&S SMIQ-K1		*)
PC Software: Bluetooth signals for R&S SMIQ	R&S SMIQ-K5		*)
PC Software: User mappings and user filters for R&S SMIQ	R&S User Mod		*)
	*) available at <a href="http://www.rohde-schwarz.com">www.rohde-schwarz.com</a>		
<b>Recommended extras</b>			
19" Adapter	R&S ZZA-94		0396.4905.00
Service Kit	R&S SM-Z3		1085.2500.02
BNC Adapter for rear panel, D type connector PAR DATA	R&S SMIQ-Z5		1104.8555.02
90° Power Splitter	R&S SMIQ-Z9		1104.9580.02
Trolley for Transit Case	R&S ZZK-1		1014.0510.00
Transit Case	R&S ZZK-944		1013.9366.00
Service Manual R&S SMIQ			1085.2445.24

Instrument upgrades		
R&S SMIQ02B to R&S SMIQ03B	R&S SMIQU03	1125.5855.03
R&S SMIQ03B to R&S SMIQ04B	R&S SMIQU04 <sup>7)</sup>	1125.5855.04
R&S SMIQ04B to R&S SMIQ06B	R&S SMIQU06 <sup>7)</sup>	1125.5855.06
Modification Kit for Low ACP	R&S SMIQU47 <sup>7)</sup>	1125.5149.02

<sup>1)</sup> PEP = peak envelope power.

<sup>2)</sup> Data apply to RF $\geq$ 5 MHz unless specified otherwise and for ATTENUATOR MODE AUTO function.

<sup>3)</sup> After 1 hour warmup time and recalibration during 4 hours of operation with temperature variations <5 °C.

<sup>4)</sup> CPDF = cumulative probability distribution function; levels referred to average value of output level.

<sup>5)</sup> Ratio of discrete and distributed component.

<sup>6)</sup> Contrast of LCD lower at higher temperature.

<sup>7)</sup> Factory installation only.

<sup>8)</sup> Spectrum analyzer settings RBW 30 kHz, VBW 300 kHz, detector RMS.

<sup>9)</sup> Typical value for QPSK modulation (crest factor approx. 4 dB), referred to average power from sum of carrier and noise power for C/N >5 dB.

Carrier leakage deteriorates with increasing crest factor of modulation signal.

<sup>10)</sup> For symbol rate <300 ksym/s.

<sup>11)</sup> Spectral components exceeding max. IQ bandwidth will be suppressed.

<sup>12)</sup> Additional error with ALC OFF <0.3 dB.

<sup>13)</sup> R&S SMIQ02B/03B (R&S SMIQ04B/06B) can be equipped with up to three (two) of the following options: R&S SM-B5, R&S SMIQB14, R&S SMIQB15, R&S SMIQB17





**ROHDE & SCHWARZ**

ROHDE & SCHWARZ GmbH & Co. KG · Mühlendorfstraße 15 · 81671 München Germany · P.O.B. 801469 · 81614 München Germany · Telephone +49 89 41 29-0  
Internet: [www.rohde-schwarz.com](http://www.rohde-schwarz.com) · CustomerSupport: Tel. +49 1805 124242, Fax +49 89 41 29-13777, E-mail: [CustomerSupport@rohde-schwarz.com](mailto:CustomerSupport@rohde-schwarz.com)